



This is a digital copy of a book that was preserved for generations on library shelves before it was carefully scanned by Google as part of a project to make the world's books discoverable online.

It has survived long enough for the copyright to expire and the book to enter the public domain. A public domain book is one that was never subject to copyright or whose legal copyright term has expired. Whether a book is in the public domain may vary country to country. Public domain books are our gateways to the past, representing a wealth of history, culture and knowledge that's often difficult to discover.

Marks, notations and other marginalia present in the original volume will appear in this file - a reminder of this book's long journey from the publisher to a library and finally to you.

Usage guidelines

Google is proud to partner with libraries to digitize public domain materials and make them widely accessible. Public domain books belong to the public and we are merely their custodians. Nevertheless, this work is expensive, so in order to keep providing this resource, we have taken steps to prevent abuse by commercial parties, including placing technical restrictions on automated querying.

We also ask that you:

- + *Make non-commercial use of the files* We designed Google Book Search for use by individuals, and we request that you use these files for personal, non-commercial purposes.
- + *Refrain from automated querying* Do not send automated queries of any sort to Google's system: If you are conducting research on machine translation, optical character recognition or other areas where access to a large amount of text is helpful, please contact us. We encourage the use of public domain materials for these purposes and may be able to help.
- + *Maintain attribution* The Google "watermark" you see on each file is essential for informing people about this project and helping them find additional materials through Google Book Search. Please do not remove it.
- + *Keep it legal* Whatever your use, remember that you are responsible for ensuring that what you are doing is legal. Do not assume that just because we believe a book is in the public domain for users in the United States, that the work is also in the public domain for users in other countries. Whether a book is still in copyright varies from country to country, and we can't offer guidance on whether any specific use of any specific book is allowed. Please do not assume that a book's appearance in Google Book Search means it can be used in any manner anywhere in the world. Copyright infringement liability can be quite severe.

About Google Book Search

Google's mission is to organize the world's information and to make it universally accessible and useful. Google Book Search helps readers discover the world's books while helping authors and publishers reach new audiences. You can search through the full text of this book on the web at <http://books.google.com/>

Ms. A. 9. 2. 5



Harvard College Library

FROM

The Institution





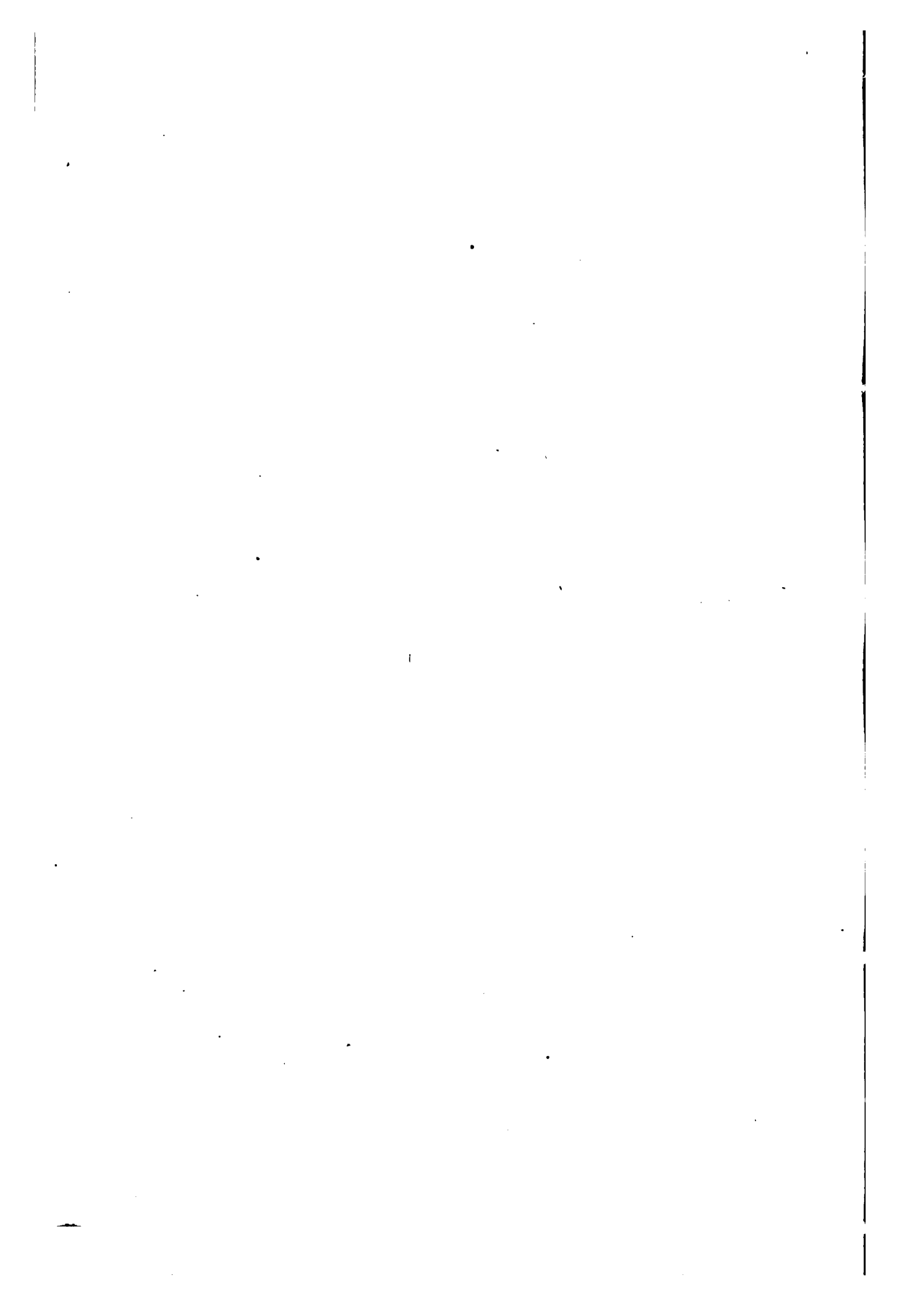

552

Phys 1846.2.5

THE DIFFUSION OF GASES THROUGH LIQUIDS AND ALLIED EXPERIMENTS

By CARL BARUS

*Hazard Professor of Physics and Dean of the Graduate Department
in Brown University*



WASHINGTON, D. C.

Published by the Carnegie Institution of Washington

1913



THE
DIFFUSION OF GASES THROUGH LIQUIDS
AND ALLIED EXPERIMENTS

By CARL BARUS

*Hazard Professor of Physics and Dean of the Graduate Department
in Brown University*



WASHINGTON, D. C.

Published by the Carnegie Institution of Washington

1913

Phys 1846.2.5

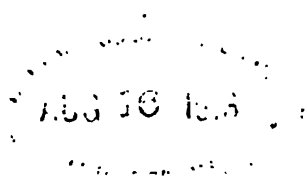

The Institution

CARNEGIE INSTITUTION OF WASHINGTON

PUBLICATION No. 186

PRESS OF GIBSON BROTHERS
WASHINGTON, D. C.

PREFACE.

Observing that the Cartesian diver used in my lectures since 1895 grew heavier from year to year, I resolved in 1900 to make definite measurements of the rate of loss of buoyancy, believing that these would be fruitful; they would bear directly on the coefficient of diffusion of the imprisoned gas through the liquid in which the diver is floating; it would be easily possible to vary the liquids and gases, within and without, under conditions of a determinable diffusion gradient. Ultimately the transfer of single molecules of a gas through the intermolecular pores of the liquid is in question, so that the experiment might throw definite light on the size of physical pores and on the other molecular relations involved.

The experiments in Chapter I, made during a period of eleven years, with an ordinary glass balloon-shaped Cartesian diver with a small aperture, culminated in a plausible value of the diffusion coefficient (*i. e.*, grams of gas or standard volume of gas transpiring per second across an orthogonal square centimeter, in case of a unit pressure gradient) of the imprisoned air through water, together with suggestive relations of the mean viscosity of the imaginary medium within the molecular pores of the liquid through which a single molecule of the gas virtually transpires. The investigation was therefore taken up on a more extended scale, for different pairs of gases.

In Chapter II the diver is modified in form and the endeavor is made to obtain equal areas in the section of the cylindrical swimmer and the annular space without, in order to conform more closely to the equation of diffusion. The theory of the phenomenon and the errors involved are discussed. It appears that, even for mixed gases, the volumes diffusing (if not the masses) are fully determinable. The accuracy essentially depends on the measurement of absolute temperature and of barometric pressure and should therefore be of an order below $1/2730$ per 0.1° C. or $1/7600$ per 0.1 centimeter of mercury. As the masses of gas contained are as a rule much less than 10^{-2} gram, even in case of air, the weight less than 0.00004 gram is determinable, showing the remarkable sensitiveness of the method. Moreover, in the region of constant temperature, the limit of sensitiveness is immensely greater.

In order to elucidate the phenomenon, experiments were begun with the transpiration of imprisoned hydrogen into air, in which the resultant diffusion is always unidirectional, outward from the diver. Initially rates as large as 5 mg. per day were obtained, which eventually decreased to a constant value, equivalent to a fixed diffusion coefficient which indicated the diffusion of air only. The case of air into air through water showed a definite mean rate throughout the two or three months of observation; but the daily march of the loss by diffusion was remarkably irregular, a result finally referred to the change of solubility of the gases in water with tem-

perature. The result of this is absorption and release of gas as temperature falls or rises, respectively, during the occurrence of the otherwise steady diffusion. In the long series the temperature effect was eliminated by the method of least squares.

Much more striking were the phenomena encountered in endeavoring to find the coefficient of diffusion of hydrogen through water into hydrogen—in which, however, the ultimate daily loss of weight of the diver became constant, corresponding to the diffusion coefficient of hydrogen alone. Referred to molecular conditions, the molecule can be regarded as moving through a medium about 15 times as viscous as ordinary hydrogen, whereas in case of air the medium would be about 13 times as viscous as air. The daily march of results in the hydrogen observations was most striking, inasmuch as the diver first lost weight at an initially enormous rate for two days, then rapidly *gained* weight at a decreasing rate during the ensuing ten days, and thereafter assumed the steady rate of loss for months. Changes of this nature are, as a rule, abrupt. It was found that a similar doubly inflected progression of results usually occurs unless all manipulations at the outset are conducted not in air, but in a medium of hydrogen, or in general of the identical gas within the diver. Otherwise the imprisoned gas is at once contaminated by diffusion of the surrounding gas into it.

It is not, perhaps, fully appreciated by chemists that gases, otherwise pure, if stored over water, at once lose purity in consequence of air by diffusion. In fact a gas, *A*, in the swimmer, in presence of gases, *B*, *C*, etc., can not escape by diffusion until the sum of the partial pressures, *B*, *C*, etc., is equal to or greater than the pressure equivalent of the head of water under which the gas *A* is submerged. Before that the gas of the environment will diffuse into the diver against the hydrostatic pressure of the head of water, *i. e.*, apparently up hill. The same explanation accounts for the enormous inflation of the microscopic air bubbles, for instance, in the liquid, when the surrounding atmosphere is some other gas, like hydrogen; also for the bubbles which still appear and grow at rough points of a surface after the effervescence of a compound gas has ceased.

Other diffusion experiments, air into hydrogen, oxygen into hydrogen, hydrogen into air, etc., were eventually pursued through months and completed in a similar manner and with similar results. The graphs obtained are throughout striking. It is feasible to derive the differential equation for these phenomena, but, as might be expected from the complications in question, it could not be integrated. Finally, it is interesting to note that if the diffusion coefficients are given, the densities of the gases diffusing at a constant rate may be computed; or, from another point of view, the degree of purity of the gas so diffusing may be ascertained.

The sensitiveness of weighing in case of the Cartesian diver, where the whole apparatus is quite submerged in water or some other liquid and capillary forces are out of the question, naturally suggested the application of this method for the measurement of high potentials in case of the absolute elec-

trometer. For this purpose the whole condenser, as described in Chapter III, is submerged in a clear non-conducting paraffin oil, while the movable disk of the electrometer is floated on a Cartesian diver, or the circular top of a cylindrical diver is itself the disk. The difference of weight of a charged and uncharged condenser is determinable, the former in view of the electrical pressures being less. It may then be shown that the absolute difference of potential of the plates, *cat. par.*, varies as their distance apart and as the square root of the difference of the manometer pressures which are just compatible with flotation, in the case of the charged and uncharged condensers, respectively. By keeping the difference in question constant, potentials may be absolutely measured in terms of the distance apart of the plates from about 50 volts to indefinitely large magnitudes.

These experiments suggested a variety of other methods. Thus the disk of the absolute electrometer, now kept in air, was buoyed up and held in place on a hydrometer, with its body submerged in water or in oil, where the capillary forces are small. Particularly interesting results were obtained when the hydrometer was a very thin, straight aluminum tube, at right angles to the light aluminum plate of the condenser, the aluminum tube being submerged in a glass tube which is one shank of a U-tube. It is shown that for a difference of potential of the disks (supposed horizontal), not too large, there is a stable and an unstable position of the movable disk, the former below the latter. The disk therefore rises from its fiducial position in the uncharged condenser to a definite height. As the difference of potential increases this height increases until at a transitional height both stable and unstable positions coincide. For greater differences of potential the disk passes without intermission from the lower plate (guard ring) to the upper plate of the condenser. If the difference of potential is constant, the same phenomena may be evoked on diminishing the distance apart of the plates of the condenser, by lowering the upper plate on a micrometer screw. Potentials may then be absolutely measured in terms of the distance apart of the plates at which the continuous rise of the disk first occurs.

Other similar experiments were devised, such as the treatment of Coulomb's law when one of the repelling bodies is a Cartesian diver, the repetition of Mayer's experiments when the charged metallic bodies are floated in oil in a charged guard ring, etc.

Finally, the experience gained in Chapter III, in relation to methods of filling the diver with a gas in an environment of the same gas, a condition rigorously necessary if the gases are to remain adequately pure for diffusion measurements, suggested the further development of certain of the experiments in Chapter II. These are given in Chapter IV. In addition to this, the chapter begins the work of treating the diffusion of gases through solutions systematically and at length. It contains the effect produced on the diffusion coefficient of air by dissolving in water different quantities of KCl, NaCl, CaCl₂, BaCl₂, SrCl₂, K₂SO₄, Na₂SO₄, FeCl₃, AlCl₃, etc. The purpose here is at present chiefly the gathering of data. The work is so laborious,

so essentially slow, and so full of pitfalls, that the serious attempt to draw conclusions from the data in hand must be deferred. It appears, however, that in all cases the physical pores of a solvent like water are effectively closed by a solute, but that the amount of closure is dependent on the character of the salt and the density of the solution in a way not to be easily surveyed. Thus a dilute solution may show greater closure than a concentrated solution of the same salt, due no doubt to the formation of hydrates effective in this respect. It appears also that the diffusion coefficients obtained from direct manometer experiments in the lapse of years are not at once comparable with the results for the divers in the lapse of months, all of which disparities will need long-continued observation.

My thanks are as usual due to Miss Ada I. Burton for most efficient assistance through the whole of this work, both in its experimental and editorial parts. The data of Chapter IV, requiring a high order of patience and accuracy, both as to observations and computation, have been largely contributed by her.

CARL BARUS.

BROWN UNIVERSITY,
Providence, Rhode Island.

CONTENTS.

CHAPTER I.—THE TRANSPIRATION OF AIR THROUGH A PARTITION OF WATER.		PAGE.
1. Molecular transpiration of a gas.....		1
2. Apparatus. Fig. 1.....		1
3. Barometer.....		1
4. Equations. Manipulation. Fig. 2.....		2
5. Data. Table 1.....		2
6. Conditions of flow.....		3
7. Coefficients of transpiration.....		4
8. Values of the coefficients.....		5
9. Conclusion.....		6
CHAPTER II.—THE TRANSPIRATION OF THE SYSTEMS AIR-AIR, HYDROGEN-HYDROGEN, AIR-HYDROGEN, HYDROGEN-AIR, ETC., THROUGH WATER.		
10. Introductory. Apparatus. Figs. 3 and 4.....		7
11. Imprisoned hydrogen diffusing into free air. Preliminary data. Fig. 5, table 2.....		8
12. Continued. Coefficients depending upon water heads only.....		10
13. Continued. Apparent frictional resistance per molecule. Virtual viscosity.....		11
14. Continued. Transpiration depending upon barometric pressure.....		12
15. Continued. Influx of air into the imprisoned hydrogen.....		13
16. Continued. Coefficients depending on diffusion gradients. Transpiration..		13
17. Continued. Flotation.....		14
18. Continued. Potential energy of the gas mixture.....		17
19. Transpiration of air into air through water. Fig. 6; table 3.....		18
20. Transpiration of hydrogen into hydrogen through water. Fig. 7; table 4...		22
21. Transpiration of imprisoned air into hydrogen through water. Fig. 8; table 5.		25
22. Transpiration of oxygen into hydrogen through water. Fig. 9; table 6.....		28
23. Transpiration of hydrogen into air through water. Fig. 10; table 7.....		31
24. Correction for density of the glass. Table 8.....		32
25. Summary. Relatively slow diffusion of mixed gases. Tables 9 and 10.....		33
CHAPTER III.—HYDROSTATIC METHODS FOR THE ABSOLUTE ELECTROMETRY OF HIGH POTENTIALS.		
I. <i>Hydrometer Methods.</i>		
26. Introduction.....		39
27. Absolute electrometer. Figs. 11 A, 11 B, 12, 13.....		39
28. Equations for the tubular float.....		42
29. Constants of the tubular float. Fig. 14.....		43
30. Constants of the conical float (capsule).....		44
31. Experiments with the tubular float. Table 11.....		45
II. <i>Absolute Electrometry by Aid of the Cartesian Diver.</i>		
32. Introductory.....		46
33. Apparatus. Fig. 15.....		47
34. Equations. Table 12.....		48
35. Measurements. Tables 13, 14.....		50
CHAPTER IV.—THE DIFFUSION OF GASES THROUGH SOLUTIONS AND OTHER LIQUIDS.		
36. Purpose.....		55
37. Apparatus. Fig. 16; table 15.....		55
38. Equations.....		57
39. Diffusion of air into air through water. Fig. 17; table 16.....		58
40. The same, continued. Fig. 18; table 17.....		61
41. Diffusion of air into air through water; further experiments. Figs. 19 A, B, C, 20; tables 18, 19, 20, 21, 22.....		62

	PAGE.
42. Diffusion of hydrogen into hydrogen through water. Fig. 21; table 23.....	66
43. Diffusion of air into air through KCl solution. Fig. 22; table 24.....	67
44. The same, continued. Fig. 23; table 25.....	69
45. The same, continued. Fig. 24; table 26.....	70
46. The same, continued. Fig. 25; table 27.....	71
47. Diffusion of air into air through NaCl solution. Fig. 26 A; table 28.....	72
48. The same, continued. Fig. 26 B; table 29.....	73
49, 50, 51, 52. Diffusion of air into air through CaCl ₂ solution. Figs. 27, 28 A, 28 B, 29; tables 30, 31, 32, 33.....	73
53, 54, 55. Diffusion of air into air through BaCl ₂ solution. Figs. 30, 31; tables 34, 35, 36.....	76
56, 57, 58. Diffusion of air into air through K ₂ SO ₄ solution. Figs. 32, 33; tables 37, 38, 39.....	78
59, 60. Diffusion of air into air through Na ₂ SO ₄ solution. Figs. 34 A, 34 B; tables 40, 41	80
61, 62. Diffusion of air into air through FeCl ₃ solution. Figs. 35 A, 35 B; tables 42, 43.	81
63. Diffusion of air into air through AlCl ₃ solution. Fig. 36; table 44.....	83
64. Diffusion of a gas through a manometer tube. Fig. 37; table 45.....	83
65. Summary. Fig. 38; table 46.....	85

THE DIFFUSION OF GASES THROUGH LIQUIDS AND
ALLIED EXPERIMENTS

By CARL BARUS

*Hazard Professor of Physics and Dean of the Graduate Department
in Brown University*

1

2

3

4

5

6

CHAPTER I.

THE TRANSPIRATION OF AIR THROUGH A PARTITION OF WATER.

1. **Molecular Transpiration of a Gas.**—Ever since 1895 I have observed that the Cartesian diver used in my lectures grew regularly heavier from year to year. The possibility of such an occurrence is at hand; for the imprisoned air is under a slight pressure-excess as compared with the external atmospheric air. But this pressure gradient is apparently so insignificant as compared with the long column of water through which the flow must take place that opportunities of obtaining quantitative evidence in favor of such transpiration seem remote. If, however, this evidence is here actually forthcoming, then the experiment is of unusual interest, as it will probably indicate the nature of the passage of a gas molecularly through the intermolecular pores of a liquid. It should be possible, for instance, to obtain comparisons between the dimensions of the molecules transferred and the channels of transfer involved.

2. **Apparatus.**—Hence on February 27, 1900, I made a series of definite experiments* sufficiently sensitive so that in the lapse of years one might expect to obtain an issue. The swimmer was a small, light, balloon-shaped glass vessel, *vd*, fig. 1, unfortunately with a very narrow mouth 2 mm. in diameter at *d*, in the long column of water *A*. The small opening, however, gave assurance that the air would not be accidentally spilled in the intervening years. For this reason it was temporarily retained, the purpose being that of getting a safe estimate of the conditions under which flow takes place.

In fig. 1, *ab* is a rubber hose filled with water, terminating in the receiver *R*. Here the lower level of water may be read off. Moreover, *R* is provided with an open hose *C*, through which pressure or suction may be applied by the mouth, for the purpose of raising or lowering the swimmer, *vd*, in the column *A*. In this way constancy of temperature is secured throughout the column.

3. **Barometer.**—The apparatus is obviously useful for ordinary barometric purposes, and provided the temperature, *t*, of the air at *v* is known to 0.025° C., the barometric height should be determinable as far as 0.1 mm. Apart from this the sensitiveness of the apparatus is surprising. Great care must be taken to avoid adiabatic changes of temperature, so that slow manipulation is essential. These and other precautions were pointed out in the original paper. The apparatus labors under one fundamental difficulty, as the diffusion of a compound gas like air is a complicated discrep-

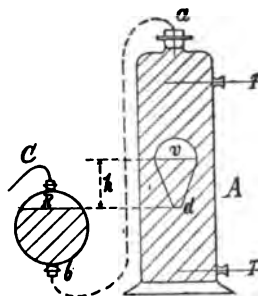

FIG. 1.—Cartesian diver adjusted for diffusion measurement.

*Am. Journ. Sci., IX, 1900, pp. 397-400.

ancy which will be felt in the lapse of time. The question will be discussed in the next chapter.

4. Equations. Manipulation.—Let h be the difference of level of the imprisoned water and the free surface in the reservoir R . Then it follows easily that

$$h + H \frac{\rho_m}{\rho_w} = \frac{Rm}{gM} \frac{\tau}{(1 + m/M) - \rho_w/\rho_g} \quad (1)$$

where H is the corrected height of the barometer (from which the mercury head equivalent to the vapor pressure of water is to be deducted), ρ_m , ρ_w , ρ_g , the densities of mercury (0° C.), water (t° C.), and glass, respectively, m the mass of the imprisoned air at v , R its gas constant, and $\tau = t + 273^\circ$ its absolute temperature. M is the mass of the glass of the swimmer and g the acceleration of gravity.

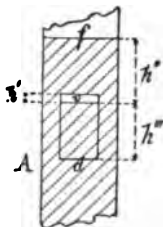

FIG. 2.—Cylindrical diver.

The equilibrium position of the swimmer is unstable. To find it R may be raised and lowered for a fixed level of the swimmer; or R may be clamped and the proper level of the swimmer determined by suction and release at C . The dropping of the swimmer throughout the column of water may occasion adiabatic change of temperature of 0.23° . It was my practice in the present experiments to use the latter method and to indicate the equilibrium position of the swimmer by an elastic steel ring encircling A . In this way the correct level may be found to about 1 mm. and afterwards read off on the cathetometer.

After making the observations, the hose ab is to be separated at a , so that the swimmer falls to a support some distance above the bottom, admitting of free passage for diffusion. Clearly this diffusion is due to the difference of level, h'' , between the water in v and at the free surface of the liquid (see fig. 2). Increase of barometric pressure has no differential effect. A large head h''' , however, means a longer column for diffusion.

5. Data.—In table 1 a few of the data made in 1900 are inserted, chosen at random.

In the intermediate time I did not return to the measurements until quite recently (January 1911), when a second series of observations was made. As much as one-fourth of the air contained in 1900 had now, however, escaped, in consequence of which the above method had to be modified and all heads measured in terms of mercury. Hence if H denotes the height of the barometer (diminished by the head equivalent to the vapor pressure of water) and if m/M be neglected in comparison with 1 (about 0.06 per cent), the equation becomes

$$m = \frac{Mg\rho_m}{R} \frac{H(1/\rho_m - 1/\rho_g)}{\tau} \quad (2)$$

in which the first factor of the right-hand member is constant. If the observations are made at the instant the swimmer sinks from the free surface in A , fig. 2, H must be increased by the mercury equivalent of the

height h'' of v . The table contains all the data reduced to mercury heads. $A = Mg\rho_m/R$. Consequently 1842×10^{-6} grams of the imprisoned air escaped in the intervening 10.92 years; *i. e.*, 0.265 of the original mass of air. In other words 168.7×10^{-6} grams per year, 0.462×10^{-6} grams per day, or 5.35×10^{-12} grams of dry air per second.

TABLE 1.—Weight m of the imprisoned air, v , fig. 1. $M=10$ grams; $\rho_m=13.6$; $\rho_g=2.87$; mouth of diver, $2r=0.2$ cm.; $A=0.0465$. Time interval 10.92 years.

Date.	Barometer.	Manometer.	Absolute temperature.	$m \times 10^{-6}$
	cm.	cm.	°	gms.
Feb. 27, 1900.....	77.21	- 3.20	297.1	6952
Feb. 27, 1900.....	77.21	- 2.36	299.2	6950
Jan. 27, 1911.....	75.77	-21.02	296.0	5110

6. Conditions of Flow.—It is now necessary to analyze the above experiment preparatory to the computation of constants. The mouth of the swimmer had an area of but 0.0314 cm.². When sunk, the head of water above the surface v was $h''=24$ cm. The column of water between v and d was $h'''=8$ cm. Hence the length of column within which transpiration took place was $24+2 \times 8=40$ cm. The right section of this column is taken as 0.0314 cm.² throughout. Naturally such an assumption, accepted in the absence of a better one, is somewhat precarious; but it may be admitted, inasmuch as the pressure of the gas sinks in the same proportion in which the breadth of the channel enlarges. Thus there must be at least an approximate compensation. In more definite experiments a cylindrical swimmer whose internal area is the same as the *annular* area without will obviate this difficulty (see fig. 2).

The pressure-difference urging the flow of air from v is

$$\Delta p = 24 \times 0.997 \times 981 = 23,470 \text{ dynes/cm.}^2$$

hence per dyne/cm.² per sec.

$$\frac{10^{-12} \times 5.346}{10 \times 2.347} = 10^{-16} \times 2.28$$

grams of air escape from the swimmer.

A few comparisons with a case of viscous flow may here be interesting. Using Poiseuille's law in the form given by O. E. Meyer and Schumann's data for the viscosity of air, it would follow that but 0.194×10^{-6} cm.³ of the 0.0314 cm.² of right section at d is open to intermolecular transpiration. The assumption of capillary transpiration is of course unwarrantable and the comparison is made merely to show that relatively enormous resistances are in question.

Again, the coefficient of viscosity

$$\frac{\eta}{1 + 4\zeta/r} = \frac{t}{m} \frac{\pi}{16} \frac{r^4}{lRt} (P^2 - p^2)$$

may be determined directly. In this equation m is the number of grams of air transpiring in t seconds through the section πr^2 and in virtue of the

pressure gradient $(P-p)/l$, when η is the viscosity and ζ the slip of the gas. Hence the value $\eta/(1+4\zeta/r) = 4.8 \times 10^6$ would have to obtain, a resistance which would still be enormously large relative to the viscosity of air ($\eta = 180 \times 10^{-6}$), even if the part of the section of the channel which is open to capillary transpiration is a very small fraction.

7. Coefficients of Transpiration.—To compute the constants under which flow takes place the concentration gradient dc/dl may be replaced either by a density gradient $d\rho/dl$ or a pressure gradient $d\phi/dl$. If the coefficients in question be k_p and k_p respectively

$$k_p = \frac{k_p}{R\tau} = \frac{\dot{m}}{a d\phi/dl} \quad (3)$$

where the section a is equal to the area of the mouth of the swimmer, R is the absolute gas constant, τ the absolute temperature of the gas, and m the loss of imprisoned air in grams per second. If $\dot{v} = \dot{m}R\tau/p$ is the corresponding loss of volume at τ and p ,

$$k_p = \frac{k_p}{R\tau} = \frac{p\dot{v}}{aR\tau d\phi/dl} \quad (3')$$

If in equation (3) the full value of m is inserted, and t denotes current time or $\dot{m} = m/t$; if

$$\frac{d\phi}{dl} = \frac{h''\rho_w g}{h'' + 2h'''}$$

where ρ_w is the density of water, h'' and h''' the difference of level (see fig. 2) of the surface in v below the free surface in A and above the mouth at d , the relations are

$$k_p = \frac{M\rho_m}{Rt} \frac{H}{\tau} \frac{1+2h'''/h''}{a\rho_w} \left(\frac{1}{\rho_w} - \frac{1}{\rho_g} \right) \quad (4)$$

$$k_p = k_p R\tau \quad (5)$$

The acceleration of gravity g has dropped from both equations; k_p is independent of $R\tau$. The coefficient k_p , however, is more perspicuous.

If h''' is made very small in comparison with h'' (care being taken to avoid loss of air during manipulation), h'' will also vanish; or for $h'' = 0$,

$$k_p = \frac{M\rho_m}{tRa\rho_w} \frac{H}{\tau} \left(\frac{1}{\rho_w} - \frac{1}{\rho_g} \right) \quad (6)$$

and similarly for $h'' = 0$

$$\dot{m} = k_p a \rho_w g \frac{1}{1+2h'''/h''}$$

reduces to

$$\dot{m} = k_p a \rho_w g$$

Thus the apparatus is most sensitive if a is as large as possible and h'''/h'' as small as possible and the length of the column in A is eventually without influence on the result. Hence if for a cylindrical swimmer the internal

right section is equal to the area of the annular space between the outer wall of the swimmer and the inner wall of the vessel *A*, if the column of water above the swimmer is removed during the prolonged intervals of time between observations, the section *a* through which capillary transpiration takes place is definitely given. It is obvious that the swimmer must be suspended, for instance by fine cross-wires, above the bottom of the tank *A*.

Reference is finally to be made to convection and to temperature. The manipulation during observation necessarily stirs up the water and distorts the regular pressure gradient. Hence observations are to be made rarely. Again, to obviate convection in general the vessel must be kept in a room of nearly constant temperature.

8. Values of the Coefficients.—If the data of table 1 be inserted in the equations for k_p and k_p ,

$$k_p = \frac{\dot{m}R\tau}{adp/dl} = \frac{5.35 \times 10^{-12} \times 2.87 \times 10^6 \times 298}{10314 \times 23470/40} = 250 \times 10^{-6}$$

$$k_p = k_p/R\tau = 0.29 \times 10^{-12}$$

Hence for a gradient of 1 dyne per centimeter, 2.9×10^{-12} grams of air flow between opposed faces of a cubic centimeter of water per second. This may be put roughly as about 2.4×10^{-10} c.c. of air per second. The speed of migration of individual air molecules intermolecularly through a wall of water is thus 2.4×10^{-10} cm./sec. for a dyne/cm. gradient.

Since the gradient is the energy expended when the cubic centimeter is transferred 1 cm. along the channel, and if the number of air molecules per cubic centimeter be taken as $N = 60 \times 10^{18}$, the force acting per molecule to give it the velocity just specified is $1/(60 \times 10^{18})$ dynes. Hence the force or drag per molecule, if its speed is to be 1 cm. per second, is

$$f = \frac{1}{2.4 \times 10^{-10}} \frac{1}{60 \times 10^{18}} = \frac{1}{144 \times 10^8} \text{ dynes} \quad f = 6.9 \times 10^{-11} \text{ dynes if } v = \text{cm./sec.}$$

This may be compared with the force necessary to move a small sphere through a very viscous liquid of viscosity η . This force is

$$f = 6\pi\eta rv$$

If $v = 1$ cm./sec., $2r = 10^{-8} \times 2$ cm. the diameter of the sphere of influence of the molecule, and $f = 6.9 \times 10^{-11}$ dynes, the value just found,

$$\eta = \frac{6.9 \times 10^{-11}}{6\pi \times 10^{-8}} = 366 \times 10^{-6}$$

In other words, the molecule moves through a liquid about twice as viscous as the air itself.

It is not improbable that from results of this kind some light will be thrown on the molecular interspaces of a liquid; for the problem in hand is ultimately that of a single molecule transferring through the intermolecular channels. The relations here obtained will, however, be considerably modi-

fied in the next chapter in connection with newer values for N and a more trustworthy value of the diffusion coefficient k than can be obtained throughout the vicissitudes of a long time interval of eleven years and a form of diver such as is here used.

9. Conclusion.—The above data are subject to the different hypotheses stated; but it has been shown that the results may be obtained by the method described free from ulterior suggestion. It seems to me that detailed investigations of the above kind carried on with reference to both the chemical and the physical properties of the liquid, *i. e.*, with different liquids and different gases at different temperatures and pressures, can not but lead to results of importance bearing on the molecular physics involved. Hence experiments of this kind were begun in this laboratory and such as have matured are reported in the following chapters.

Obviously in a doubly closed water manometer (U-tube), the unequal heads of the two columns of liquid must in a way similar to the above vanish in the lapse of time. This method seems particularly well adapted to obviate convection, and has also been adopted, though it requires long time intervals. Finally, hydrogen actually shows a measurable amount of molecular transpiration in the daily march of results obtained; but their extremely complicated character was not foreseen at the outset. They are not, therefore, available for discussion until they have been thoroughly analyzed in the way to be treated in Chapter II.

CHAPTER II.

THE TRANSPIRATION OF THE SYSTEMS AIR-AIR, HYDROGEN-HYDROGEN, AIR-HYDROGEN, HYDROGEN-AIR, ETC., THROUGH WATER.

10. Introductory. Apparatus.—In the preceding chapter preliminary data were given for the molecular transpiration of air, obtained from an eleven-year period of observations of the increase of weight of a Cartesian diver. This apparatus was ill-adapted for the experiments, because of its small mouth. Consequently cylindrical swimmers have since been installed, both for air and for hydrogen, and often showed sufficiently rapid progress to admit of a statement of results after several weeks. In fig. 3, vd is the diver in the column of water A , usually resting in an elevated position on the vertical wire-gauze partition, e . The imprisoned air is shown at v in contact with the lower water-level, and f is the level of the free surface of water. The tubes a and b , the latter containing a glass stopcock, are useful in exhaustion, or in special experiments for the conveyance of an artificial atmosphere of hydrogen into the space above the free surface f . T is the thermometer placed eccentrically. The heads h' , h'' , h''' will be referred to below.

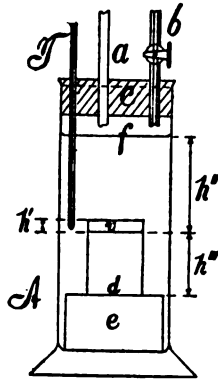

FIG. 3.—Cylindrical diver adjusted for diffusion measurement.

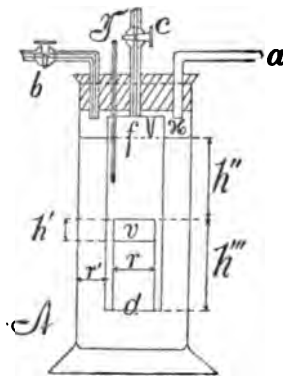

FIG. 4.—Cartesian diver with double tube.

This form of apparatus is suitably modified in the way shown in fig. 4, with a view to making uniform the section of the column of water through which diffusion takes place. Here the swimmer vd is contained in a central tube cd (with a stopcock at c) full of water. The swimmer fits the tube with just sufficient freedom to slide easily. The tube is then partially surrounded by the water in the larger vessel A . There may be a stop near the top at f to determine the level of flotation. This is particularly necessary, both here and in fig. 3, when the top of the swimmer is flat. The advantages of this form are many; in the first place, the section r and the annular section r' of the diffusion column may be made the same throughout, within, around, and above the swimmer, which is not the case in fig. 3; the level f may be sharply determined, since there is no danger of the rider parting the water at the surface. Discrepancies due to friction of convection currents are diminished. The heads h' , h'' , and h''' may be more

accurately measured. Finally, the whole arrangement is more conducive to constancy of temperature in the essential parts of the apparatus than is the case in fig. 3.

11. Imprisoned Hydrogen Diffusing into Free Air. Preliminary Data.—As before the mass m' of hydrogen contained at v in the swimmer is given by

$$m' = \frac{Mg\rho_m}{R} \frac{H}{\tau} \left(\frac{1}{\rho_w} - \frac{1}{\rho_g} \right) \quad (1)$$

where Mg is the weight of the glass swimmer, ρ_m the density of mercury at 0°C ., ρ_w the density of water at t° , and ρ_g the density of glass. H is the barometric height diminished by the head equal to the vapor pressure of water vapor, τ the absolute temperature, and R the gas constant of hydrogen. The latter applies at the outset only. Since

$$\begin{aligned} M &= 18.09 \text{ grams} & \rho_m &= 13.6 \\ g &= 981 & R &= 41.4 \times 10^6 \end{aligned}$$

the constant $A = Mg\rho_m/R = 0.005823$. The hydrogen used was obtained electrolytically from water, enough being introduced into the swimmer to just prevent flotation.

In the course of time the gases contained in the diver will change from the influx of diffused air and the efflux of hydrogen. Hence the gas constant R of the imprisoned gas is not fixed in value. Supposing, however, all observations to be made or all diffusion to occur at a certain mean pressure B and temperature τ ; since for all gases $R\rho = R_0\rho_0$, the latter referring to the initially pure gas at the given temperature and pressure (supposed, as stated, to be constant during flotation); and since, finally,

$m = v'\rho' = v\rho$, during and before flotation, therefore

$$v = \frac{Mg\rho_m}{R_0\rho_0} \frac{H}{\tau} \left(\frac{1}{\rho_w} - \frac{1}{\rho_g} \right) = M \left(\frac{1}{\rho_w} - \frac{1}{\rho_g} \right) \frac{H}{B} \quad (1')$$

so that the variations of volume v are referred to in taking the quantity $A = Mg\rho_m/R$ constant. To pass from v to the mass m it will be necessary to multiply A by ρ/ρ_0 where the density ρ of the imprisoned gas is not known. I shall suppose that the variation of temperature and pressure during a long period may be eliminated by the method of least squares. Hence only the coefficients of diffusion by volume, called κ below, are determinable. The coefficient of diffusion by mass, k , can not, apparently, be found at once, except for a system of but one gas.

Table 2 contains the observations made preliminarily with hydrogen, in so far as they are trustworthy. These and others are reproduced in fig. 5,

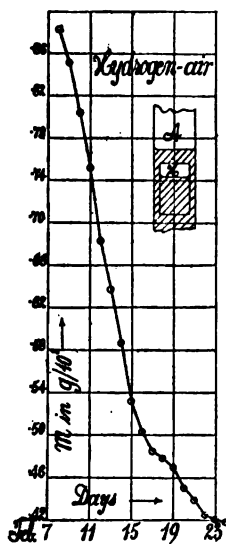

FIG. 5.—Loss of mass of gas in diver in lapse of days. Diffusion of hydrogen into air.

m' being shown in the lapse of time. The curve is at first nearly linear in its descent and thereafter is sharply flexed to the right. This is in a measure due to the fact that much hydrogen has escaped, and the lower surface of the bubble v is now no longer equal to the area or cross-section of the swimmer. Hence the transpiration proceeds with diminished area, and therefore more slowly. Subsequent experiments, however, will show that this flexure of the curve is, in the main, real (§23).

There are other difficulties which ultimately enter, owing to the fact that the exhaustion needed to make the diver float is so large that the gases

TABLE 2.—Molecular transpiration of hydrogen into air, through a wall of water. $A=0.005823$; $M=18.09$ grams; $\rho_m=13.6$; $1/\rho_p=0.3486^*$; $h'=0.06$ cm.; $h''=11.0$ cm.; $h'''=5.5$ cm.; $l=22.0$ cm.; areas 12.6 cm.² and 24.6 cm.²; $a=12.0$ cm.²; mean τ , 22° ; $R=41.45 \times 10^6$; $\rho_A=89.55 \times 10^{-6}$.

Date.	Hour, afternoon.		H	t	$m \times 10^6$	$-\dot{m} \times 10^{10}$
	$h.$	$m.$	cm.	°C.	gms.	gms./sec. †
1911. Feb. 8.....	0	0	67.74	19.4	883	6.23
9.....	1	30	66.29	21.5	858	6.27
9.....	4	0	65.99	22.4	852	6.37
10.....	4	0	62.44	23.2	804	Mean:
11.....	0	0	58.27	22.4	752	6.29
12.....	5	20	53.05	23.4	683
13.....	4	0	49.41	22.8	637
14.....	3	30	45.44	21.9	587
15.....	5	0	40.93	19.8	532

*Provisional value. See § 24.

†Taken from four-day groups: Feb. 9 to 13; 10 to 14; 11 to 15.

dissolved in the water come out, on exhaustion, prior to observation. Hence all these results are discarded. To obtain a long period of trustworthy values the diver should either be weighted (a heavier diver will hereafter be used) requiring more gas to float it, or the gas should be in excess, so that the diver sinks only under excess of pressure. Both modifications are in a measure undesirable. Massive parts endanger the accuracy of the temperature datum, and pressure excess requires a U-tube manometer, which is less easily read at an instant than the barometric form.

Hence

$$\begin{aligned} k_p &= 1.07 \times 10^{-13} & k_p &= k_p R \tau = 1.31 \times 10^{-5} \quad (\S 12) \\ &= 1.15 \times 10^{-15} & k_p &= k_p R \tau = 1.40 \times 10^{-5} \quad (\S 13) \end{aligned}$$

Observations of the above kind, though exceptionally delicate in themselves, are marred by a difficulty which I have not quite been able to overcome. Whenever the temperature differs from that of the room there will be vortical convection currents, which by their friction on the walls of the diver tend either to raise or to depress it. Hence such experiments should preferably be made in a room of constant temperature (if available), or at least in the summer.

12. Continued. Coefficients Depending upon Water Heads Only.—It will be expedient to compute the coefficients of molecular transpiration, *tentatively*, under a variety of hypotheses, before making a more careful examination of the case. There are at the outset two points of view from which the coefficients of transpiration may be calculated, since in fig. 3 the gas at v (hydrogen), is different from the gas at f (air). Thus the pressure gradient may either be taken as the mere excess of pressure at v over that of f , *i.e.*,

$$\frac{dp}{dl} = \frac{h''\rho_w g}{h'' + 2h'''} = \frac{\rho_w g}{1 + 2h'''/h''} \quad (2)$$

since *both* gases hydrogen and air are saturated with moisture; or the gradient may be taken as the full barometric pressure plus the head, *i.e.*,

$$\frac{dp}{dl} = \frac{H + h''\rho_w g}{h'' + 2h'''} \quad (3)$$

since there is no hydrogen above f and both gases, hydrogen and air, are saturated with water. To decide between these and other hypotheses it will ultimately be necessary to introduce for comparison an artificial atmosphere of hydrogen at f , as is done in §20 below. Moreover, if the diffusion takes place subject to equation (3), air must in like manner diffuse from f into v , and a phenomenon of considerable complication result, as is actually the case.

Leaving the theoretical discussion for more adequate treatment below, it is interesting preliminarily to examine equations (2) and (3) separately. Postulating equation (2), the (virtual) coefficients k for a pressure gradient are respectively, if a is the area of the mouth of the swimmer, and \dot{m}' the loss of imprisoned air per second for the gradient dp/dl ,

$$k = \frac{\dot{m}'}{a dp/dl} = \frac{\dot{m}'}{a} \frac{1 + 2h'''/h''}{\rho_w g} \quad (4)$$

Here $2h''' = 11$ cm., $h'' = 11$ cm., therefore $1 + 2h'''/h'' = 2$. The mean temperature may be taken at 22° or $\rho_w = 0.998$; $g = 981$, $a = 12$ cm.², thus

$$k = \dot{m}' \frac{2}{12 \times 0.998 \times 981} = 170 \times 10^{-6} \dot{m}'$$

The pressure gradient dp/dl is 489 dynes/cm. Hence, since

$$\dot{m} = -6.29 \times 10^{-10} \text{g/sec.}$$

the value of the initial coefficients is at 22° , for hydrogen, if the air influx is ignored,

$$k = 1.07 \times 10^{-13}$$

Here k is the rate in grams/sec., under the hypothesis stated, at which hydrogen transpires molecularly between opposed faces of a cubic centimeter of water, when the gradient is one dyne/cm.

I may remark in passing that from equation (4)

$$\dot{m}' = k a \rho_w g / (1 + 2h''/h')$$

the individual values of m' from day to day should vary with ρ_w or with temperature; but this amounts to but 0.02 per cent per degree and is thus insufficient to explain the zigzag passage of some of the curves obtained; for instance, that of the transpiration of air into air through water (§19), or of hydrogen into hydrogen (§20), quantitatively. Moreover, the zigzag is of a positive and negative character and hence quite beyond the reach of such a discrepancy. It has been referred partly to the effect of vortices due to convection (frictional pull of water on the swimmer), or again to an actual evolution and absorption of the imprisoned gas from the water below, as temperature rises and falls. Finally, since the true mass rate, \dot{m} , for mixed gases is obtained from \dot{m}' , by

$$\dot{m} = \dot{m}' \frac{\rho}{\rho_0} \quad (5)$$

where ρ_0 refers to hydrogen and therefore for the given mixture, *cat. par.*, \dot{m} is constant, $\dot{m}'\rho$ must also be constant. In other words, \dot{m}' as computed will vary inversely as the actual density ρ of the gas, *i. e.*, \dot{m}' will increase as temperature rises and decrease as temperature falls. The effect of temperature is not, however, marked in these experiments. It is so, however, for an air-air system, for which the latter explanation does not apply, Hence the cause of the irregularity is probably absorption and release, as specified.

13. Continued. Apparent Frictional Resistance per Molecule. Virtual Viscosity.—The above coefficient, k , nominally shows the grams per second of hydrogen which transpire molecularly for a pressure gradient of one dyne/cm. at 22°. As the density of hydrogen at 22° is about 82.3×10^{-6} the volume coefficient will be

$$\kappa = k / 82.3 \times 10^{-6} = 1.30 \times 10^{-9}$$

Here κ is the true coefficient of transpiration by volume.

It may be interesting to inquire in passing what the virtual viscosity would be under which the molecule transpires for a pressure gradient of dyne/cm. when 1.3×10^{-9} c.c. of hydrogen transpire molecularly between opposed faces of a cubic centimeter, or the velocity of the molecule is $v = 1.3 \times 10^{-9}$ cm./sec. If the resistance, which is really kinetic, be regarded as due to a continuous medium of virtual viscosity η , we may write the force f urging a single molecule of radius r with a speed v

$$f = 6\pi\eta r v$$

Thus the force which urges $N = 60 \times 10^{18}$ molecules (O. E. Meyers's estimate of the number per cubic centimeter, if the effective diameter of each is $2r = 2 \times 10^{-8}$ cm.) will be

$$F = 3\pi\eta \times 2 \times 10^{-8} \times 60 \times 10^{18} \times v$$

Now, the above velocity corresponds to a pressure gradient dyne/cm., *i. e.*, to a loss of energy of 1 erg per cubic centimeter for a transfer of the cubic centimeter of gas along 1 cm., *i. e.*, to a resistance of $F = 1$ dyne. Thus for the stated value of v

$$\eta = 68 \times 10^{-6}$$

The viscosity of hydrogen at 22° , according to Puluji, is 91.5×10^{-6} . Hence if the present method of computation, which ignores the air influx, were correct, it would follow that the molecular transpiration of hydrogen through the intermolecular pores of water takes place at a rate corresponding to the order of its viscosity. The experiments of the sequel (§§19, 20), however, show that this simple method of computation is not admissible for hydrogen-air diffusion, or at least not until the pressure gradients due to the heads of water quite hold in check the further influx of air due to diffusion.

14. Continued. Transpiration Depending upon Barometric Pressure.—

If, again, the initial influx of air into the swimmer be ignored, while the efflux of gas due to diffusion gradients is alone considered, the gradients take the form

$$\frac{dp}{dl} = g \frac{(B - \pi)\rho_m + h''\rho_w}{h'' + 2h'''} \quad (6)$$

where B is the height of the barometer and ρ_m and ρ_w the densities of mercury and water, π the vapor pressure of water vapor (referred to mercury), h'' the effective head of water, $h'' + 2h'''$ the length of the diffusion column. The mean temperature was 22° , the mean barometer 76.21 cm., and the vapor pressure 2 cm. Thus

$$\frac{dp}{dl} = 981 \frac{74.21 \times 13.6 + 11 \times 0.998}{11 + 11} = 45,500 \text{ dyne/cm.}$$

whence, since $a = 12 \text{ cm.}^3$ and $\dot{m}' = 6.29 \times 10^{-10}$, the auxiliary

$$k = \dot{m}' / a(dp/dl) = 1.15 \times 10^{-15}$$

If these coefficients be taken per cubic centimeter instead of per gram of hydrogen transpiring per second, under normal conditions, the volume coefficient will be

$$\kappa = k / 82.3 \times 10^{-6} = 1.40 \times 10^{-11}$$

Hence the velocity of transpiration for a dyne/cm. gradient is $v = 1.4 \times 10^{-11}$ cm./sec.

Finally the virtual viscosity of the medium through which the single molecule is dragged by the gradient would be, since the resistance $F = 1$,

$$\eta = 1 / 6\pi Nrv = 6,310 \times 10^{-6}$$

In other words, the viscosity under the tentative hypothesis stated would be about 70 times as large as that of hydrogen.

The decision as to the applicability of either of these, or similar hypotheses, can not be given until the work is repeated with an artificial atmosphere of hydrogen at f in fig. 3, in place of air; or after other similar variations of experiment. The results (§20) show that in the earlier stages of the work, at least, the behavior throughout is then totally different. Hence it is necessary to investigate the question from a broader point of view and relative to the two simultaneous diffusions in opposite directions through the same channel.

15. Continued. Influx of Air into the Imprisoned Hydrogen.—In view of the fact that for a single gas m increases uniformly in the lapse of time, the initial counterflux of air may also be computed directly, independent of the flow of hydrogen. In this way additional light is thrown upon the phenomenon, preliminarily. Thus if k_a and p_a refer to air

$$\dot{m}_a = k_a a dp_a/dl = k_a a \frac{(B-\pi)\rho_w g - p_a}{h'' + 2h'''} = k_a 12 \frac{74.21 \times 13.6 \times 981}{22} \quad (7)$$

where p_a is zero at the beginning of the experiment and where k_a has the value found in §19, 1.09×10^{-12} . Hence $\dot{m}_a = 5.89 \times 10^{-8}$ grams/sec. or 5.09×10^{-3} grams/day. Initially ($t=0$ sec.), therefore, the swimmer should gain 5.1 mg. per day, due to the influx of air into the imprisoned hydrogen. In the lapse of time this rate would naturally be much reduced in consequence of the counter-pressure of the air accumulating in the swimmer; nevertheless the initial rate of influx (5.89×10^{-8} grams/sec.) is so large, as compared with the observed rate of efflux, 6.29×10^{-10} grams/sec. in table 2, as to show that two counter-currents of air and hydrogen are simultaneously transpiring, at rates relatively not very different in value. It is therefore necessary to investigate these currents in detail.

16. Continued. Coefficients Depending on Diffusion Gradients. Transpiration.—This case might at first seem improbable. If the hydrogen diffuses outward under full barometric pressure at v , fig. 3, there being no hydrogen at f , the air must diffuse inward from f to v , since there is no air originally at v ; but when the hydrogen has nearly vanished, or its pressure excess at v is equivalent to a diffusion gradient $h''\rho_w g$ along fv , the air or a mixed air-hydrogen gas would again have to diffuse outward, due to the specified head or increment of pressure at v as compared with f . Such complications would hardly be expected in so simple an experiment and yet this is precisely what seems to take place. I have therefore developed the equations tentatively as follows.

Let p_h and p_a be the pressures of hydrogen and of air at any time at v , fig. 3. Let B be the constant barometric pressure during diffusion and π the vapor pressure of water. Then

$$B + h''\rho_w g = p_a + p_h + \pi \quad (8)$$

where the constant $\Pi = p_h + p_a = B + h''\rho_w g - \pi$ may be used for abbreviation.

Let \dot{m}_a and \dot{m}_h be the masses of air and of hydrogen transpiring per second, into and out of the imprisoned volume, v . Hence, if a is the area of the water level at v ,

$$-\dot{m} = -(\dot{m}_h - \dot{m}_a) = a(k_h d\dot{p}_h/dl - k_a d\dot{p}_a/dl) \quad (9)$$

is the variation of mass per second, if k_h and k_a are the coefficients for hydrogen and air, respectively. But

$$\frac{d\dot{p}_a}{dl} = \frac{B - \pi - \dot{p}_a}{h'' + 2h'''} = \frac{\dot{p}_h - h''\rho_w g}{h'' + 2h'''} \quad \frac{d\dot{p}_h}{dl} = \frac{\dot{p}_h}{h'' + 2h'''} \quad (10)$$

where ρ_w is the density of water and g the acceleration of gravity. Hence

$$-\dot{m} = a(k_h - k_a) \frac{\dot{p}_h}{h'' + 2h'''} + ak_a \frac{\rho_w g}{1 + 2h'''/h''} \quad (11)$$

Therefore, when \dot{p}_h vanishes in the lapse of time, the diffusion of air alone is in question and \dot{m} will be constant. The datum actually measured, however, is $\dot{m}' = \dot{m}\rho/\rho_0$, where ρ is the density of the imprisoned mixed gas and ρ_0 the density of the initial gas, hydrogen, all at the supposedly fixed mean temperature and pressure assumed. Thus it will be necessary to refer equation (11) to diffusion by volume and write, κ being the coefficient,

$$-\dot{v} = a(\kappa_h - \kappa_a) \frac{\dot{p}_h}{h'' + 2h'''} + a\kappa_a \frac{h''\rho_w g}{h'' + 2h'''} \quad (12)$$

In equation (12) if \dot{p}_h were to vanish or become negligible, the transpiration of air would alone be in question and \dot{v} would be constant, supposing that κ_h and κ_a are really constant, or that the phenomenon is homogeneous. For a diffusion and a transpiration phenomenon may occur side by side, subject to different laws; the first depending upon the degree of mixture of the gases and rapidly vanishing as the mixture is more nearly complete, the second depending upon the head h'' . It does not follow, however, in view of §15, that \dot{p}_h will vanish first; for when $\dot{p}_h = h''\rho_w g$, $\dot{p}_a = B - \pi$, and the influx of air must cease, because the air gradient has vanished. Hence thereafter hydrogen and air will both diffuse out of the swimmer; for any further diminution of \dot{p}_h means an increase of \dot{p}_a which is now greater than $B - \pi$. A mixture of gases thus diffuses which grows continually richer in air and poorer in hydrogen, until it is nearly pure air.

Equations (11) and (12) are not integrable, since \dot{m} is independent of m and \dot{v} independent of v .

17. Continued. Flotation.—Admitting equation (12), the endeavor must now be made to express \dot{p}_h or its equivalent in terms of quantities belonging to the mixture, or to express \dot{m} in terms of ρ , the density of the imprisoned gases.

Let P be the artificial barometric pressure on flotation, and let \dot{p}'_a and \dot{p}'_h be the corresponding pressures of the dry air and hydrogen imprisoned.

Then if the position of the swimmer remains unaltered and temperature is constant

$$P + k'' \rho_w g - \pi = p'_a + p'_h = \Pi' \quad (13)$$

while above, equation (8)

$$B + k'' \rho_w g - \pi = p_a + p_h = \Pi$$

Π' is variable in time, whereas Π is constant. Moreover

$$B - P = (p_a - p'_a) + (p_h - p'_h) \text{ and } \dot{P} = \dot{p}'_a + \dot{p}'_h \quad (14)$$

$$\dot{p}_a + \dot{p}_h = 0 \quad (15)$$

The ratio $(p_a + p_h)/(p'_a + p'_h)$ is not the same as B/P but equal to Π/Π' .

The imprisoned volume v' at constant temperature on flotation will be rigorously

$$v' = \frac{M(1/\rho_w - 1/\rho_g)}{1 - p_a/R_a \rho \tau - p_h/R_h \rho \tau - \pi/R_g \rho_g \tau} \quad (16)$$

if R is the gas constant for air, hydrogen, and water vapor, as indicated by subscripts. The second, third, and fourth terms of the denominator are not larger than 0.00098 at ordinary temperatures and variable to less than 0.00001 per degree. Hence they are negligible as compared with the large variations of m found in experiment, which amount to several per cent. Thus

$$v' = M(1/\rho_w - 1/\rho_g) \quad (17)$$

nearly enough for all purposes, and hence

$$m = m_a + m_h = \frac{M(1/\rho_w - 1/\rho_g)}{\tau} \left(\frac{p'_a}{R_a} + \frac{p'_h}{R_h} \right) \quad (18)$$

in terms of mercury heads if

$$A = v' \rho_m g, \quad (19)$$

the condition of flotation is

$$m = \frac{A}{\tau} \left(\frac{H'_a}{R_a} + \frac{H'_h}{R_h} \right) \quad (20)$$

We may, on the other hand, express the pressures without coefficients, v' being given by equation (17),

$$v' \Pi' = (R_a m_a + R_h m_h) \tau \quad (21)$$

Again, since v' is constant,

$$v' \dot{P} = (R_a \dot{m}_a + R_h \dot{m}_h) \tau \quad (22)$$

at constant temperature; or from equation (18)

$$\dot{m} = \frac{A}{g \rho_m \tau} \left(\frac{\dot{p}'_a}{R_a} + \frac{\dot{p}'_h}{R_h} \right) \quad (23)$$

Between the variables belonging to Π and Π' respectively there is an immediate relation, since on mere expansion for flotation

$$p_a/p_h = p'_a/p'_h \quad (24)$$

at any time, from which p' may be reduced to p ; or, for instance, in case of equation (18)

$$m = \frac{v'}{\tau} \left(\frac{p_a}{R_a} + \frac{p_h}{R_h} \right) \frac{p'_h}{p_h}; \text{ etc.} \quad (25)$$

Finally, the initial mass, m_0 , of hydrogen imprisoned must be given, corresponding to the initial volume $v = v_0$, not expanded like v' for flotation; v is variable while v' is constant. Hence

$$m_0 = v_0 \Pi / R_h \tau \quad (26)$$

and at any subsequent time

$$m = m_a + m_h = \frac{v}{\tau} \left(\frac{p_h}{R_h} + \frac{p_a}{R_a} \right) \quad (27)$$

which reduces to

$$\rho = \frac{p_h}{\tau} \left(\frac{1}{R_h} - \frac{1}{R_a} \right) + \rho_0 \frac{R_h}{R_a} \quad (29)$$

ρ being the density of the mixture undergoing transpiration at t seconds and ρ_0 the density of the pure hydrogen at $t=0$ seconds.

The value of p_h given in equation (29) may now be inserted into equation (11), whereupon this becomes

$$-\frac{\dot{m}}{a} = \Pi \frac{1 - R_a \rho / R_h \rho_0}{1 - R_a / R_h} \frac{k_h - k_a}{h'' + 2h'''} + k_a \frac{h'' \rho_w g}{h'' + 2h'''} \quad (31)$$

which is perhaps the most acceptable form of the equation for \dot{m} ; but, as stated above, it can not be integrated, because $\rho = \rho_a + \rho_h = m/v$, both of which (m and v) are variable in the lapse of time. Since $\dot{m}' = \dot{m} \rho_0 / \rho$ is observed, the equation is advantageously referred to volume. If the mean temperature and pressure are assumed constant throughout, implying

$$R_a \rho / R_h \rho_0 = R_a / R$$

where R the gas constant of the mixture,

$$\frac{\dot{v}}{a} = \Pi \frac{1 - R_a / R}{1 - R_a / R_h} \frac{\kappa_h - \kappa_a}{h'' + 2h'''} + \kappa_a \frac{h'' \rho_w g}{h'' + 2h'''} \quad (32)$$

If \dot{m} or \dot{v} is constant, a result which eventually appears in all the experiments, it follows that ρ is constant, *i. e.*, a gas mixture of definite composition or density eventually diffuses, since

$$\ddot{m} = a \Pi \frac{k_h - k_a}{h'' + 2h'''} \frac{R_a}{R_a - R_h} \frac{\dot{\rho}}{\rho_0}$$

but the density, ρ , of this mixture is not given. If, however, \dot{m} is observed ρ may be computed (equation 31). If $\rho = \rho_0$

$$-\dot{m} = a\Pi k_h / (h'' + 2h''') - ak_a(\Pi - h''\rho g) / (h'' + 2h''') \quad (33)$$

depending upon two nearly equal counter-currents, since Π is relatively large. If eventually $\rho = \rho_a$, since $R_a \rho_a = R_h \rho_0 = R_h \rho_h$,

$$-\dot{m} = ak_a h'' \rho_a g \quad (34)$$

the diffusion of air alone due to the head h'' .

Finally, in a manner similar to the above, one may deduce

$$\dot{v} = \frac{\tau a}{\Pi(h'' + 2h''')} \left\{ p_h(R_a k_a + R_h k_h) - R_a k_a h'' \rho_a g \right\} \quad (35)$$

18. Continued. Potential Energy of the gas mixture.—If the mixed gases are to be separated, the work to be done is given by

$$W = v p_h \log p_h / \Pi + v p_a \log p_a / \Pi \quad (36)$$

since the hydrogen is to be compressed isothermally from v and p_h to Π and the air similarly from v and p_a to Π , v being the volume of gas while transpiration is taking place at $\Pi = p_h + p_a$. Thus the work per unit of volume is

$$W_0 = \frac{W}{v} = p_h \log \frac{p_h}{\Pi - p_h} + \Pi \log \frac{\Pi - p_h}{\Pi} = \log \frac{p_h^p (\Pi - p_h)^{\Pi - p}}{\Pi^\Pi} \quad (37)$$

If there is eventually to be but a single gas present, the above equation for W must be modified, to include the relative importance of the head h'' of water on the imprisoned gas. In other words,

$$p_h + p_a = \Pi + h'' \rho_a g = \Pi + p' \text{ (say)}$$

and therefore

$$\frac{W}{v} = p_h \log \frac{p_h}{\Pi + p' - p_h} + (\Pi + p') \log \frac{\Pi + p' - p_h}{\Pi} \quad (38)$$

Hence, if p_h is equal to zero, on expansion (since p'/Π is also very small)

$$\frac{W}{v} = (\Pi + p') \left(\frac{p'}{\Pi} + \dots \right) = p' = h'' \rho_a g, \text{ nearly.}$$

The potential energy per unit of volume is constant.

The rate at which potential energy is lost per second on mixture is per unit of volume

$$\frac{\dot{W}}{v} = -\dot{p}_h \log \left(\frac{\Pi + p'}{p_h} - 1 \right) + \frac{\dot{v}}{v} \log \frac{p_h^p (\Pi + p' - p_h)^{\Pi + p' - p_h}}{\Pi^{\Pi + p'}} \quad (39)$$

if $\dot{v} = 0$,
$$dW/dp_h = -v \log \frac{\Pi + p' - p_h}{p_h}$$

if $\dot{p}_h = 0$,
$$dW/dv = W/v$$

If $p_h = \Pi + p'$ or $p_a = 0$, initially,

$$\frac{\dot{W}}{v} = -\dot{p} \log 0 + p_h \frac{\dot{v}}{v} \log \frac{p_h}{\Pi} = -\dot{p} \log 0 + p' \frac{\dot{v}}{v}, \text{ nearly.}$$

It follows therefore, initially, when $p_h = \Pi + p'$ or $p_a = 0$, there being a charge of hydrogen only,

$$\dot{W}/v = \infty$$

for all reasonable values of \dot{p}_h and \dot{v} . Hence diffusion, to keep pace with the loss of potential energy per second, should be extremely rapid at the outset.

The observations below, as a rule, show enormously rapid transpiration at the beginning of the experiment, which thereafter rapidly diminishes and is often reversed in the lapse of time. There can be little doubt, therefore, that in the cases of mixed gases the rate at which the potential energy of the system diminishes may be invoked to interpret the observed phenomenon, particularly when the diffusion take place, on the whole, against the gradients due to the water heads. Beyond this, however, *i. e.*, further than as a means of pointing out the source of energy, the potential energy of separated gases will not probably need to be considered.

19. Transpiration of Air into Air Through Water.—Tentative results of this kind were given in the preceding chapter, from observations lasting a period of about eleven years. The swimmer was unsuitable for the purpose, but the datum found, $k = 2.9 \times 10^{-13}$, should furnish an estimate as to the probable order of values to be anticipated.

In table 3 I have given the present results, so far as they have matured, showing the daily diminution of the mass (m in grams) of the imprisoned air.

Figure 6 contains the value of m in milligrams on successive days. As the observations can not be in error, even as much as 0.1 per cent, the marked discrepancy encountered must have some real cause. True, the opportunities for constant temperature were not at hand and there is interference with the gradient due to convection, in the case of an apparatus like fig. 3; but the actual increase of weight can not apparently be referred to these causes, except in so far as $m = m' \rho / \rho_0$, in equation (5). There are two other explanations: If the temperature of the column of water is not exactly that of the environment during observation there will be eddy currents, which will raise and depress the swimmer by friction with its sides. This was actually tested on February 27 by artificially heating the apparatus from without. The swimmer is then too heavy, due to a downward axial current and the charge of air found too small. The discrepancy, however, is inadequate in amount. The predominating cause seems to be associated with the effect of temperature on the solution* of gases in water. At higher temperatures gas is evolved from the water and caught by the swimmer and the imprisoned air is therefore too heavy. At lower temperatures the gas of the swimmer is absorbed into water and the charge of air is too light. As this effect is inherent in the experiment itself, there is no way of combating it except the maintenance of absolutely constant temperature. The coefficients will eventually have to be computed by the method of

*The final curve for the hydrogen-hydrogen system is much smoother than the corresponding curves for mixed gases under the same conditions. Hence the preference given to the solution effect.

TABLE 3.—Diffusion of air through water into air.

$$m = \frac{Mg\rho_m H}{R} \left(\frac{1}{\rho_w} - \frac{1}{\rho_a} \right); M=12.01 \text{ grams}; R=2.87 \times 10^8; \rho_m=13.6; A=Mg\rho_m/R=0.05583;$$

$l=28.0 \text{ cm.}; h''=15.0 \text{ cm.}; 2h'''=13.0 \text{ cm.}; 1/\rho_a=0.3486; * \text{ water head } 0.11 \text{ cm.}$

Diameters: Vessel=4.3 cm.; float=2.5 cm. Areas: $A'=14.5 \text{ cm.}^2; A=7.05 \text{ cm.}^2$

Date.	Hour.	Barometer.	H	l	Observed $m \times 10^4$	Computed $m \times 10^4$	$\Delta m \times 10^4$
Jan. 31..	h. m.	75.89	69.51	17.8	8548	8498	+ 50
Feb. 1..	76.73	69.50	18.4	8523	8463	+ 60
2..	75.10	67.71	19.4	8259	8428	-169
3..	76.80	65.54	16.4	8262	8393	-131
4..	74.76	66.69	22.2	8255	8358	-103
6..	77.04	64.57	15.2	8172	8288	-116
7..	76.16	64.22	16.6	8091	8253	-162
8..	76.44	64.33	18.7	8051	8218	-167
9..	75.84	65.34	22.4	8075	8183	-108
10..	75.49	66.21	23.1	8174	8148	+ 26
11..	76.54	65.22	22.8	8058	8114	- 56
17..	4 00	76.15	61.16	17.0	7697	7904	-207
18..	4 15	75.37	64.72	26.2	7916	7869	+ 47
19..	4 35	76.06	64.59	24.0	7952	7834	+118
20..	4 45	75.01	63.57	21.3	7892	7799	+ 93
21..	4 45	75.88	62.98	21.5	7813	7764	+ 49
22..	4 35	75.30	62.67	22.2	7758	7729	+ 29
23..	4 40	75.51	62.54	22.0	7747	7694	+ 53
24..	4 15	74.87	62.91	24.2	7741	7659	+ 82
25..	3 15	75.52	63.46	26.8	7747	7624	+123
26..	4 10	75.72	63.58	25.6	7790	7590	+200
27..	4 00	75.91	62.98	23.8	7758	7555	+203
28..	4 05	76.14	61.15	20.6	7607	7520	+ 87
Mar. 1..	3 50	75.00	61.28	23.6	7553	7485	+ 68
2..	3 40	74.71	62.26	27.0	7598	7450	+148
3..	3 35	75.64	58.89	15.6	7444	7415	+ 29
4..	3 40	75.99	59.35	21.1	7372	7380	- 8
5..	5 00	77.04	58.95	21.0	7325	7345	- 20
6..	4 00	76.37	59.13	23.2	7297	7310	- 13
7..	3 30	77.25	58.76	22.2	7273	7275	- 2
8..	3 45	76.60	59.12	24.8	7261	7240	+ 21
9..	3 45	76.02	58.91	22.0	7297	7205	+ 92
10..	3 45	74.59	57.78	18.3	7240	7170	+ 70
11..	3 45	76.38	56.93	18.5	7130	7135	- 5
12..	4 00	75.87	56.01	16.6	7056	7100	- 44
13..	4 00	76.73	56.10	18.9	7016	7066	- 50
14..	3 45	76.59	55.09	17.0	6932	7031	- 99
15..	3 45	74.44	55.55	20.0	6923	6996	- 73
16..	4 00	75.44	53.94	13.1	6874	6961	- 87
17..	3 30	76.64	53.51	16.6	6742	6926	-184
18..	3 45	75.80	54.92	22.4	6794	6891	- 97
19..	4 00	76.04	55.87	22.9	6900	6856	+ 44
20..	3 30	74.51	56.30	23.2	6964	6821	+143
21..	3 45	75.57	55.31	20.2	6889	6786	+103
22..	3 30	74.61	54.80	20.7	6815	6751	+ 64
23..	3 30	75.46	54.34	18.8	6799	6716	+ 83
24..	3 30	76.54	53.20	17.5	6684	6681	+ 3
25..	3 45	77.02	52.34	17.2	6582	6646	- 64
26..	4 30	76.54	52.80	21.4	6552	6611	- 59
27..	3 45	75.07	53.25	21.5	6606	6577	+ 29
28..	3 45	74.59	53.97	22.3	6678	6542	+136
29..	4 00	74.83	53.64	22.2	6640	6507	+133
30..	4 00	73.77	53.27	21.2	6614	6472	+142
31..	4 00	74.58	52.55	19.6	6573	6437	+136

*Cf. §24.

TABLE 3—Continued.

Date.	Hour.	Barometer.	H.	<i>t</i> .	Observed $m \times 10^6$.	Computed $m \times 10^6$.	$\Delta m \times 10^6$.
Apr.	<i>h. m.</i>						
1..	3 30	75.37	51.40	17.6	6455	6402	+ 53
2..	5 00	75.97	49.92	15.9	6304	6367	- 63
3..	3 30	76.71	49.18	16.3	6202	6332	-130
4..	4 00	77.07	48.68	16.3	6139	6297	-158
5..	4 00	75.27	48.80	17.2	6137	6262	-125
6..	3 45	75.31	49.64	19.5	6197	6227	- 30
7..	3 00	75.47	50.08	20.2	6238	6192	+ 46
8..	4 30	76.43	49.39	18.0	6195	6157	+ 38
9..	4 30	76.28	48.49	17.0	6101	6122	- 21
10..	4 00	76.86	48.34	19.0	6045	6087	- 42
11..	3 30	77.25	47.98	19.0	6000	6053	- 53
12..	3 30	77.52	47.58	18.2	5964	6018	- 54
13..	4 00	77.36	47.27	18.8	5914	5983	- 69
14..	3 45	76.26	47.07	17.5	5913	5948	- 35

least squares. The run of the thermometer on the same sheet, fig. 6, bears out this surmise. The barometer, like the vapor pressures, shows no easily discernible relation to the weight curve; but the run of temperature foreshadows the kinks in the m curve throughout its extent.



FIG. 6.—Loss of mass of gas in diver in lapse of days. Diffusion of air into air.

If we write for the air-water system (time t in days, mass m in grams)

$$m = m_0 - \dot{m}t$$

and compute the constants m_0 and \dot{m} by the method of least squares from the 68 observations made between January 31 and April 11, the values obtained are

$$m_0 = 0.0085327 \text{ gram} \quad \dot{m} = 0.00003493 \text{ gram/day}$$

The data for m calculated with these constants are also inscribed in table 3. The errors show the fluctuation of the temperature cycles. They may be regarded as eliminated from the curve as a whole. The rate m per day reduced to seconds gives

$$\dot{m} = 4.04 \times 10^{-10} \text{ grams/sec., at about } 20^\circ$$

Hence

$$k = \frac{4.04 \times 10^{-10}}{7.05 \times 524} = 1.09 \times 10^{-13}$$

The new value is thus much smaller than the tentative value, $k = 2.9 \times 10^{-13}$ found from the balloon-shaped Cartesian diver, with small mouth ($2r = 0.2$ cm.) after a period of eleven years. The uncertainty surrounding the latter datum, in view of the long time-interval and the unfavorable shape, etc., did not lead me to expect more than an order of values. The values of k , moreover, involve the change of the gas constant, or mixture. Nevertheless the agreement should apparently have been closer. Moreover, even in the present method, a , h'' , and h''' are not yet very accurately determinable and the equation $l = h'' + 2h'''$ needs a correction for $2h'''$. The path out of and around the diver is actually longer than $2h'''$. It does not, however, seem worth while to apply these refinements until a room of perfectly constant temperature has been secured.

Finally, it is interesting to compute the virtual viscosity of the intermolecular space through which the air molecule transpires. The coefficient of diffusion taken per cubic centimeter (κ being independent of R and therefore correct) will be

$$\kappa = \frac{1.09 \times 10^{-13}}{0.0012} = 0.91 \times 10^{-10}$$

whence the velocity of transpiration for a gradient of dyne/cm. is also $v = 9.1 \times 10^{-10}$ cm./sec. Writing, as above,

$$\eta = F/6\pi Nrv$$

where $F = 1$ dyne, $N = 60 \times 10^{18}$ molecules per cubic centimeter, $2r = 2 \times 10^{-8}$ cm. (O. E. Meyer's values),

$$\eta = \frac{1}{6 \times 3.142 \times 60 \times 10^{18} \times 10^{-8} \times 0.91 \times 10^{-10}} = 970 \times 10^{-6}$$

The viscosity of air is 190×10^{-6} . Thus the virtual viscosity of the medium is to this extent about 5 times that of normal air.

If we take Millikan's* recent data for N and $2r$, viz,

$$N = 2.64 \times 10^{19} \quad 2r = 2.89 \times 10^{-8} \text{ (oxygen)} \quad 2r = 3.06 \times 10^{-8} \text{ (nitrogen)}$$

and regard $2r = 3 \times 10^{-8}$ cm. as the average molecular diameter for air, $2Nr = 0.7932 \times 10^{11}$ replaces $2Nr = 12 \times 10^{11}$ above; whence

$$\eta = 1455 \times 10^{-6}$$

or the virtual viscosity of the intermolecular medium would be nearly 8 times as large as normal air.

*Millikan, Physical Review, xxxii, pp. 349 et seq., 1911.

If the correction for Stokes's law be introduced, v must be replaced by

$$v = \frac{1 + 2\xi/r}{1 + 3\xi/r}$$

where ξ is the coefficient of slip. If $\xi = 7.6 \times 10^{-8}$, an order of values given by Millikan (*l. c.*), since $2r$ is but 3×10^{-8} , v is to be replaced by $2v/3$. This makes η about 50 per cent larger, or the virtual viscosity of the medium is finally

$$\eta = 2180 \times 10^{-6}$$

or about 11.5 times as large as the viscosity of normal air. Finally, if the correction for the density of glass given in §24 is inserted, this factor is increased to about 13.

20. Transpiration of Hydrogen into Hydrogen Through Water.—The behavior of hydrogen alone is peculiar. Hydrogen was imprisoned in the swimmer, as usual, on the first day (see table 4). The upper surface was still in contact with atmospheric air; hence the marked loss of weight, the potential energy of separated gases being dissipated at the initial very large rate. Thereafter, however, the air was replaced by an artificial atmosphere of hydrogen from the gasometer, whereupon the large loss of weight from February 25 to 26 almost at once changes to a gain, which in its turn at first grows enormously, finally to decrease again to a smaller but still persistent gain. This feature is probably due to the air dissolved in the water (see fig. 7). Temperature modifies these data somewhat, but the fact remains that hydrogen apparently diffuses through water, from low to high pressure; *i. e.*, up-hill or against the pressure gradient. This is an interesting result, showing, like the first sudden drop, the importance of the mixture effect. The potential energy of separated gases is being dissipated at a rapid rate. Possibly some dissolved air at first diffuses into the swimmer; but eventually hydrogen diffuses into it in excess of the outgo of air; for in view of the pressure p_a of the diffused air within the swimmer and since $p_h + p_a$ is constant, p_h is less than the pressure $B - \pi$ of the artificial atmosphere of hydrogen on top. The data after March 2 and as far as March 9 show the trend of approximately

$$\dot{m} = 1.7 = 10^{-6} \text{ g/day or } 0.2 \times 10^{-10} \text{ g/sec.}$$

the result being a remarkably regularly increase of weight. One may note that all these changes of direction are abrupt. Whether this is merely accidental or whether certain definite mixtures diffuse together remains to be seen. Unfortunately air is not a simple gas, so that the behavior of three gases is really involved.

A peculiar result during this stage of diffusion and occurring in all similar cases is the enormous enlargement of microscopic air bubbles attached to the solid surfaces wherever they are in contact with water. These are sought out by the hydrogen, and soon become visible and greatly enlarged

by the flow of hydrogen into them, so that they finally break off or may be shaken off. After the first few days such bubbles no longer occur. This is additional confirmation to the effect that hydrogen here diffuses from apparent low pressure to apparent high pressure, so far as water levels are concerned, in cases where it enters a medium of air, however small; *i. e.*, the gradients due to mixture imply that $p_a > h''\rho_w g$, $p_b < B - \pi$, since $p_a + p_b = B + h''\rho_w g - \pi$ is constant. Wherever the water is continuous or in actual contact with the glass, no bubbles are produced. Neither do they ever occur for the diffusions of air into air.

TABLE 4.—Diffusion of hydrogen through water into hydrogen.

$A = 0.005823$; $M = 18.09$; $\rho_m = 13.6$; $h' = 0.8$ cm.; $h'' = 11.0$ cm.; $h''' = 5.5$ cm.; $l = 22.0$ cm.;
 $1/\rho_g = 0.3486^*$; water-head 0.06 cm. Hg.
 Areas: 12.6 cm.²; 24.6 cm.². Diameters: 4.0 cm.; 5.6 cm.

Date.	Hour.	Barometer.	H	l	Observed $m \times 10^6$	Computed $m \times 10^6$	$\Delta m \times 10^6$
	<i>h. m.</i>			<i>°</i>			
Mar. 15..	4 00	74.44	61.51	20.0	799	804	- 5
16..	4 00	75.44	59.67	13.1	793	795	- 2
17..	3 30	76.64	59.19	16.9	777	785	- 8
18..	4 00	75.80	60.18	22.6	776	775	+ 1
19..	4 00	76.04	59.65	22.4	769	765	+ 4
20..	3 30	74.51	59.46	23.4	764	756	+ 8
21..	3 45	75.57	58.03	20.2	754	746	+ 8
22..	3 30	74.61	56.97	20.9	739	736	+ 3
23..	3 30	75.46	55.66	19.0	726	726	0
24..	3 30	76.54	54.01	17.8	707	717	- 10
25..	3 45	77.02	53.17	17.7	696	707	- 11
26..	4 30	76.54	53.25	21.5	689	697	- 8
27..	3 45	75.07	53.16	21.8	687	688	- 1
28..	3 45	74.59	53.02	22.4	684	678	+ 6
29..	4 00	74.83	52.37	22.2	676	668	+ 8
30..	4 00	73.77	51.63	21.2	668	658	+ 10
31..	4 00	74.58	50.53	19.6	657	649	+ 8
Apr. 1..	3 30	75.37	48.99	17.9	641	639	+ 2
2..	5 00	75.97	47.41	16.0	624	629	- 5
3..	3 30	76.71	46.51	16.6	613	619	- 6
4..	4 00	77.07	46.01	16.5	605	610	- 5
5..	4 00	75.25	45.49	16.8	597	600	- 3
6..	3 45	75.31	45.82	19.7	596	590	+ 6
7..	3 00	75.47	45.39	20.2	589	580	+ 9
8..	4 30	76.43	44.17	18.2	577	571	+ 6
9..	4 30	76.28	43.02	17.3	564	561	+ 3
10..	4 00	76.86	42.46	19.2	553	551	+ 2
11..	3 30	77.25	41.36	19.0	539	542	- 3
12..	3 30	77.52	40.05	17.8	524	532	- 8
13..	4 00	77.36	39.62	19.1	516	522	- 6
14..	3 45	76.25	38.98	17.8	510	512	- 2

*Cf. §24.

After March 9, however, the regular decrease of weight begins, again abruptly, due to the transpiration of hydrogen in accordance with the pressure gradient (water-heads) alone. After March 20 it progresses with satisfactory uniformity until April 14, when the experiments were broken off, as it seemed improbable that further characteristic changes would occur.

To compute the constants for the diffusion of hydrogen into hydrogen through water, data from March 17 to April 14 were treated by the method of least squares, as shown in table 4. If

$$m = m_0 - \dot{m}t$$

(time in days) the constants are

$$m_0 = 814.1 \times 10^{-6} \text{ grams} \quad \dot{m} = 9.734 \times 10^{-6} \text{ grams/day}$$

From these the rate per second follows as

$$\dot{m} = 1.1266 \times 10^{-10} \text{ g/sec.}$$

The constants of the apparatus are

$$a = 12 \text{ cm.}^2 \quad h'' = 11 \text{ cm.} \quad 2h''' = 11 \text{ cm.} \quad l = 22 \text{ cm.}$$

Thus

$$\frac{d\phi}{dl} = \frac{h'' \rho_w g}{h'' + 2h'''} = 489 \text{ dyne/cm.}$$

and therefore

$$k = \frac{\dot{m}}{ad\phi/dl} = 1.92 \times 10^{-14}$$

involving, however, the change of gas constant. Hence the true coefficient κ , referred to unit of volume transpiring, if the density of hydrogen be taken as 89.5×10^{-6} is

$$\kappa = 2.14 \times 10^{-10}$$

or the velocity of transpiration is 2.14×10^{-10} cm./sec. This is, therefore, more than twice as large as in case of air, where $\kappa = 0.91 \times 10^{-10}$.

It follows, finally, that the virtual viscosity, η , of the intermolecular gas through which the hydrogen molecule supposedly transpires, if $N = 60 \times 10^{18}$, $2r = 2 \times 10^{-8}$ cm. (O. E. Meyer), is

$$\eta = 1/6\pi Nrv = 0.000413$$

The viscosity of hydrogen at ordinary temperatures is normally 91.5×10^{-6} . Hence the virtual viscosity of the intermolecular hydrogen would be four and a half times larger than its normal viscosity.

Using Millikan's data for N and r , viz,

$$N = 2.64 \times 10^{19} \quad 2r = 2.28 \times 10^{-8} \text{ cm.}$$

the datum $2Nr = 6.03 \times 10^{11}$ replaces $2Nr = 12.0 \times 10^{11}$, whence

$$\eta = 826 \times 10^{-6}$$

Here in turn the discrepancy of Stokes's equation is to be added. If it is applied, the value of η will be further increased about 50 per cent or the virtual viscosity of the intermolecular medium is finally

$$\eta = 1240 \times 10^{-6}$$

or about 13.5 times the normal viscosity of hydrogen. Correcting as in §24, the factor becomes 15, which does not agree with the corresponding datum for air (about 13 times) as well as the values found above appeared to predict.

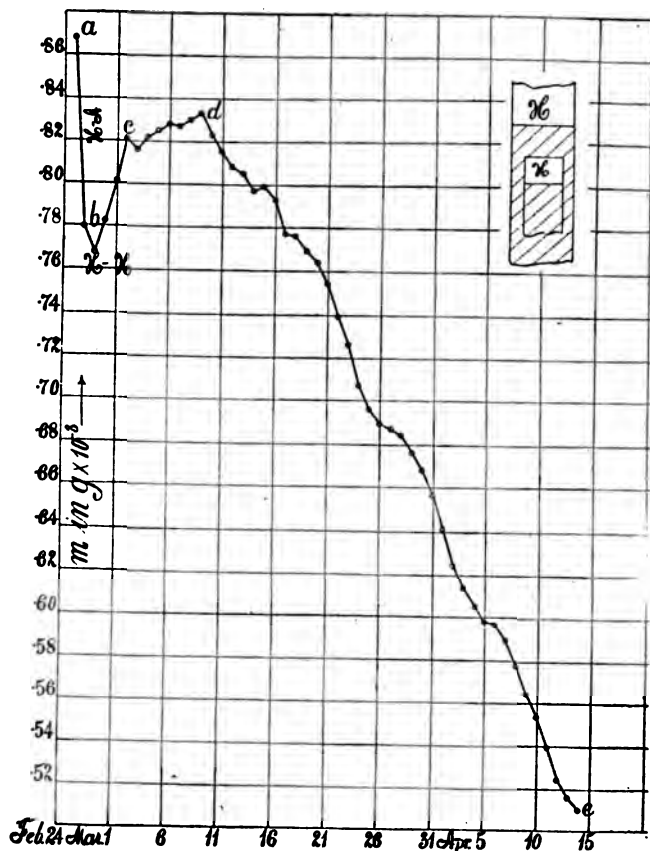

FIG. 7.—Chart showing loss of mass of gas in diver in lapse of days. Diffusion of hydrogen into hydrogen.

21. Transpiration of Imprisoned Air into Hydrogen Through Water.— The immediate use of equation (1) is inadmissible, since the gas constant R varies, as the gas within the swimmer changes its composition. But since at a given pressure and temperature $R\rho$ is constant for all mixtures,

$$m = v\rho = \frac{Mg\rho_m}{R} \frac{H}{\tau} \left(\frac{1}{\rho_w} - \frac{1}{\rho_p} \right)$$

is still the correct value, relatively to volume, as intimated above. It is merely necessary, therefore, to coordinate the correct value of ρ for the initial gas and its gas constant R , after which the equation is applicable to all subsequent gas mixtures, if the diffusion κ by volume is to be computed; but \dot{m} is now merely an apparent rate, and k merely a transitional value.

The experiment of this section is the converse of those briefly detailed in table 2 and repeated at greater length in a following paragraph (23). The data are given in table 5 and are shown graphically in fig. 8. During the

TABLE 5.—Diffusion of air through water into hydrogen. $M=14.45$; $g=981$; $\rho_m=13.6$; $R_a=2.87 \times 10^6$; $a=6.4$ cm.; $A=Mg\rho_m/R_a=0.06717$; $h'=1.5$ cm.; $h''=10$ cm.; $h'''=5$ cm.; $1/\rho_0=0.3486$.*

Date.	Hour.	Barom-eter.	H	t	$m \times 10^6$	Date.	Hour.	Barom-eter.	H	t	$m \times 10^6$
	<i>h. m.</i>			°			<i>h. m.</i>			°	
Mar.	6 5 00	76.37	53.59	21.4	8002	Apr.	12 3 30	77.52	61.18	17.8	9239
	7 4 00	77.25	57.21	22.6	8510		13 4 00	77.36	60.79	19.3	9137
	8 4 00	76.60	61.98	24.8	9159		14 3 45	76.26	60.12	18.0	9074
	9 4 00	76.02	64.81	22.8	9636		15 3 00	75.81	59.85	20.1	8972
	10 4 15	74.59	65.70	18.8	9890		16 3 30	75.25	58.87	19.2	8851
	11 4 00	76.38	66.84	19.0	10055		17 3 30	75.45	57.10	18.0	8618
	12 4 00	75.87	67.23	17.1	10176		18 4 00	75.67	55.74	18.6	8396
	13 4 00	76.73	68.36	19.2	10277		19 4 00	75.69	54.62	17.0	8271
	14 4 15	76.59	68.36	17.4	10336		20 3 45	75.10	53.52	16.3	8121
	15 4 00	74.44	69.79	20.4	10453		21 4 00	75.50	52.52	16.8	7957
	16 4 00	75.44	68.26	13.1	10407		22 4 00	76.14	51.10	17.0	7737
	17 3 30	76.64	68.73	17.1	10402		23 4 00	76.37	49.52	16.2	7517
	18 4 15	75.80	70.03	22.8	10410		24 4 00	76.02	49.13	17.5	7426
	19 4 00	76.04	69.96	22.4	10413		25 4 00	76.26	48.19	18.6	7259
	20 3 30	74.51	70.55	23.6	10462		26 3 30	76.82	47.16	18.4	7108
	21 3 45	75.57	70.07	20.5	10491		27 3 15	76.88	46.47	20.0	6970
	22 3 30	74.61	70.13	21.0	10483		28 3 15	76.33	46.16	21.0	6902
	23 3 30	75.46	69.43	19.1	10442		29 4 00	75.77	45.43	21.2	6788
	24 3 30	76.54	68.54	18.0	10343		30 4 00	75.58	44.12	20.0	6617
	25 3 45	77.02	68.40	17.8	10328	May	1 3 45	75.02	43.66	20.5	6537
	26 4 30	76.54	69.49	21.8	10361		2 4 00	74.91	43.34	20.2	6496
	27 3 45	75.07	69.74	21.9	10397		3 4 00	75.71	42.77	19.2	6430
	28 3 45	74.59	70.08	22.6	10424		4 4 15	76.14	42.48	19.2	6387
	29 4 00	74.83	69.87	22.5	10397		5 4 00	76.35	42.12	18.3	6351
	30 4 00	73.77	69.60	21.5	10388		6 4 00	76.48	41.88	19.0	6301
	31 4 00	74.58	68.87	20.0	10328		7 4 30	76.06	41.54	19.2	6246
Apr.	1 3 30	75.37	67.76	20.0	10226		8 4 00	75.93	39.58	20.5	5926
	2 5 00	75.97	66.59	16.1	10111		9 4 00	74.95	38.02	21.3	5679
	3 3 30	76.71	66.08	17.0	10003		10 4 00	75.32	37.77	21.5	5638
	4 4 00	77.07	65.63	16.8	9897		11 4 00	75.69	37.89	22.0	5648
	5 4 00	75.27	65.35	17.2	9889		12 4 00	75.90	38.09	21.8	5680
	6 3 45	75.31	65.83	20.0	9871		13 4 30	75.92	37.97	22.3	5654
	7 3 00	75.47	65.76	20.2	9855		14 4 30	76.81	37.56	20.6	5623
	8 4 30	76.43	64.70	18.3	9754		15 4 00	76.14	37.29	20.5	5583
	9 4 30	76.28	63.53	17.5	9603		16 4 00	75.74	37.11	22.2	5528
	10 4 00	76.86	63.21	19.6	9491		17 4 00	75.93	37.27	22.2	5552
	11 3 30	77.25	62.32	19.5	9360						

*Cf. §24.

first days and later the swimmer rapidly increases in weight, at least at first; the influx of hydrogen or the initial apparent rate is about

$$\dot{m} = 0.000550 \text{ g/day} = 64 \times 10^{-10} \text{ g/sec.}$$

and it thus much exceeds the converse case of table 2; but this rapid influx is soon reduced in the lapse of time.

The bubble phenomenon, due to the diffusion of hydrogen into microscopic air-bubbles adhering to solid parts, under water, was equally prominent. During the early days these gathered in great quantity and had to be shaken off. It would be interesting to estimate the virtual pressure at

which the bubbles are initially expanded. In fact, if the pressure within be taken as $p=4T/r$, where T is the surface tension and r the radius of the sphere, if the bubbles grow almost from the order of microscopic dimensions, say from $r=10^{-4}$ cm., we may put

$$p=4 \times 80 / 10^{-4} = 3.2 \times 10^8 \text{ dynes/cm.}^2$$

Thus the initial pressure would have to be of the order of several atmospheres, if this explanation is correct. As not more than one atmosphere is available, the original air-bubbles should be larger than 6×10^{-4} cm. in diameter to expand.

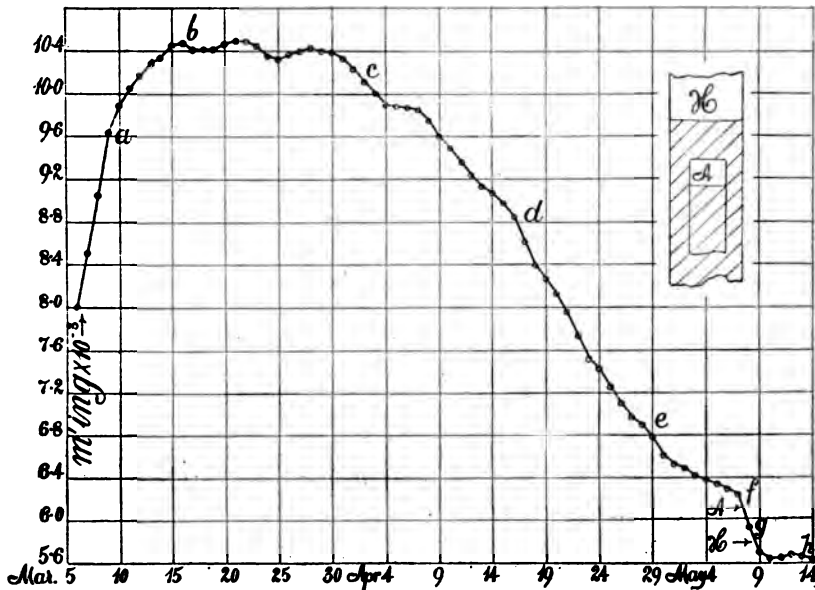

FIG. 8.—Chart showing loss of mass of gas in diver in lapse of days.
Diffusion of air into hydrogen.

Between March 9 and 16 the rate has somewhat abruptly decreased (*a* to *b* in curve).

Between March 16 and 30 the weight of the imprisoned air was nearly stationary (*b* to *c* in curve), a condition of things which has again been reached abruptly. Hence the per second influx of hydrogen and the efflux of air are here about equal, remembering, however, that m is not the actual mass.

From March 20 the pronounced efflux suddenly begins, at a specific though slowly increasing rate until April 30 (*cde* in curve). It would seem to be probable that during this interval the content of the swimmer is largely hydrogen; and yet the apparent mass rate of efflux is

$$m = 160 \times 10^{-6} \text{ g/day or } 18 \times 10^{-10} \text{ g/sec.}$$

a relatively large value.

Since the area of diffusion is $a = 6.4 \text{ cm.}^2$ and

$$h'' = 10 \text{ cm.} \quad h''' = 5 \text{ cm.} \quad l = h'' + 2h''' = 20 \text{ cm.} \quad \frac{dp}{dl} = 490 \frac{\text{dyne}}{\text{cm.}^2}$$

(apparent) $k = 0.6 \times 10^{-12}$. Thus the volume coefficient is

$$\kappa = 4.9 \times 10^{-10}$$

Hence comparing the coefficients per unit of volume it appears that for air-air $\kappa = 0.91 \times 10^{-10}$; for hydrogen-hydrogen, $\kappa = 2.14 \times 10^{-10}$; for air-hydrogen, $\kappa = 4.92 \times 10^{-10}$.

Thus the present coefficient is over 5 times as large as the corresponding coefficient for air and over twice as large as the coefficient for hydrogen. Hence the mixture transpiring can not be pure hydrogen. The reason for this large κ is difficult to ascertain.

In fact (curve e to f) after April 30 till May 7 the rate abruptly diminishes again to

$$-\dot{m} = 51 \times 10^{-6} \text{ g/day} = 5.9 \times 10^{-10} \text{ g/sec.}$$

whence $k = 1.57 \times 10^{-10}$ which is now below the value for hydrogen, as it should be.

On May 7, the upper atmosphere of hydrogen was accidentally forgotten and replaced by air for but one day. The loss of weight thereafter is enormous, showing that the contents must at least have approached pure hydrogen. The artificial atmosphere of hydrogen was replaced on the next day, but the recovery of the curve is slow (f to g in curve) and corresponds to the initial behavior of hydrogen (§20) above. Thereafter to June 10, the mean rate is $-\dot{m} = 26 \times 10^{-6} \text{ g/day} = 3.0 \times 10^{-10} \text{ g/sec}$. From this coefficients are obtained as $k = 0.97 \times 10^{-12}$ and $\kappa = 0.81 \times 10^{-10}$. Hence, as usual, the influx of air has enormously reduced the final rate by diminishing the partial pressure of hydrogen.

22. Transpiration of Oxygen into Hydrogen Through Water.—These results, which contain the first example of the behavior of two simple gases, are given in table 6 and in fig. 9. One may note the enormously rapid rate of efflux (a to b in curve), on the first day. The mean apparent rate (relative to mass) during this day was in fact

$$-\dot{m} = 8.2 \times 10^{-4} \text{ g/day} = 9.5 \times 10^{-9} \text{ g/sec.}$$

nearly 30 times as large as the final rate and about ten times as large as the initial rate of the hydrogen-air system. This might seem to be due to the solubility of oxygen in water, but it will probably be explained in terms of the relatively high density of this gas. The rapid diffusion ceases after the first day, when the greater part of the oxygen will have escaped. The case is particularly remarkable, as the rate is necessarily the difference between the influx of hydrogen and the efflux of oxygen, so that the actual rate of loss of oxygen must have been relatively enormous.

On the six succeeding days (curve, from b to c) the influx of hydrogen into the swimmer about balances the efflux of oxygen from the swimmer. There-

after (curve, *c* to *d*) the steady efflux begins, the behavior being at first very irregular, as usual for oxygen. The rate here, so far as observed, is

$$-\dot{m} = 32 \times 10^{-6} \text{ g/day or } 3.7 \times 10^{-10} \text{ g/sec.}$$

The constants of flotation, etc., are

$$h'' = 14.5 \text{ cm.} \quad 2h''' = 13.6 \text{ cm.} \quad l = 28.1 \text{ cm.,} \quad a = 7.05 \text{ cm.}^2$$

Hence

$$\frac{d\phi}{dt} = 505 \text{ dynes/cm.} \quad k = 1.04 \times 10^{-13} \quad \kappa = 0.78 \times 10^{-10}$$

which is somewhat less than the rate found above for air into air with the same apparatus. What is diffusing, however, must be a mixture of oxygen

TABLE 6.—Diffusion of oxygen through water into hydrogen and vice versa. $M = 12.01$ grams; $R_0 = 2.60 \times 10^8$; $\rho_m = 13.6$; $A = 0.0617$; $h' = 1.1 \text{ cm.}$; $h'' = 14.5 \text{ cm.}$; $h''' = 6.8 \text{ cm.}$; $1/\rho_0 = 0.3486$; $l = 28.1 \text{ cm.}$; areas 14.5 cm.^2 ; $a = 7.05 \text{ cm.}^2$, $a' = 7.45 \text{ cm.}^2$; correction = 0.08 cm. Hg.

Date.	Hour.	Barom-eter.	H	t	$m \times 10^6$	Date.	Hour.	Barom-eter.	H	t	$m \times 10^6$
	<i>h. m.</i>			^o			<i>h. m.</i>			^o	
Apr. 14	5 00	76.26	72.17	18.2	9999	May 12	4 00	75.90	58.03	21.7	7953
	15 3 00	75.81	66.69	20.3	9179		13 4 30	75.92	58.17	22.2	7960
	16 3 30	75.25	65.89	19.0	9107		14 4 30	76.81	57.75	20.6	7942
	17 3 30	75.45	65.66	17.6	9115		15 4 00	76.14	57.25	20.5	7893
	18 4 00	75.67	65.64	18.5	9086		16 4 00	75.74	57.47	22.1	7867
	19 4 00	75.69	65.57	16.8	9124		17 4 00	75.93	57.65	22.1	7892
	20 3 45	75.10	65.65	16.2	9154		18 4 00	75.32	57.53	21.3	7894
	21 4 00	75.50	65.68	16.5	9150		19 4 00	75.86	57.51	21.9	7878
	22 4 00	76.14	65.30	16.8	9088		20 4 00	76.08	57.37	22.8	7836
	23 4 00	76.37	64.55	16.0	9007		21 4 30	76.09	57.00	22.0	7805
	24 4 00	76.02	64.49	17.2	8964		22 4 00	75.82	56.95	22.5	7786
	25 4 00	76.26	64.91	18.4	8987		23 4 00	76.40	57.08	23.2	7787
	26 3 30	76.82	64.80	18.2	8978		24 4 00	76.11	56.99	22.8	7784
	27 3 15	76.88	64.92	20.0	8945		25 4 00	75.69	57.13	23.6	7771
	28 3 15	76.33	65.35	21.0	8976		26 4 00	75.96	56.67	23.3	7730
	29 4 00	75.77	65.22	21.2	8952		27 4 00	76.22	56.00	22.7	7651
	30 4 00	75.58	64.44	20.2	8873		28 4 30	76.20	55.36	21.6	7589
May 1	3 45	75.02	64.34	20.6	8847		29 4 00	75.95	55.37	21.8	7586
	2 4 00	74.91	64.11	20.4	8821		30 4 00	76.22	55.37	21.3	7598
	3 4 00	75.71	63.61	19.1	8789		31 3 30	75.91	55.39	21.8	7589
	4 4 15	76.14	63.34	19.0	8754	June 1	4 00	74.96	56.07	23.5	7643
	5 4 00	76.35	62.86	18.1	8712		2 5 00	75.55	55.91	23.4	7641
	6 4 00	76.48	62.77	18.8	8680		3 3 15	76.25	55.42	22.1	7586
	7 4 30	76.06	62.63	19.0	8656		4 4 30	76.38	54.87	21.6	7521
	8 4 00	75.93	60.12	20.2	8278		5 3 45	76.20	54.27	20.2	7472
	9 4 00	74.95	57.76	21.2	7926		6 3 30	76.09	54.28	22.0	7433
	10 4 00	75.32	57.41	21.5	7873		8 4 00	76.11	54.15	22.5	7403
	11 4 00	75.69	57.69	21.9	7901		9 4 00	75.70	54.06	22.4	7393

*Cf. §24.

and hydrogen with a preponderance of the latter, since the inward diffusion of hydrogen ceases when (subscripts indicating the gases)

$$p_h = B - \pi \text{ and } p_0 = h'' \rho_w g$$

Thereafter, since p_0 must decrease indefinitely, p_h becomes greater than $B - \pi$. Thus $h'' \rho_w g$ becomes an index for the composition of the diffusing

gas mixture, here hydrogen and oxygen, and it is therefore not remarkable that the final coefficients of the linear march are all specific of the mixture. This fact is particularly borne out by the following phenomenon. On May 7 to 8 the artificial atmosphere of hydrogen was accidentally replaced by an atmosphere of air but for one day. The usual effect of an enormous loss, continuing for a day thereafter, even though the atmosphere of hydrogen was replaced, is apparent (*d* to *e* in curve). After May 9 the period of recovery begins, efflux and influx being at first about equal (*e* to *f* in curve). The rapid loss on May 7 to 9, in response to the atmosphere of air on May 7 to 9, shows that the contents of the swimmer must have been largely hydrogen gas. The prolongation of the effect for another day is probably due to air in the water. Changes of rate are, as usual, abrupt.

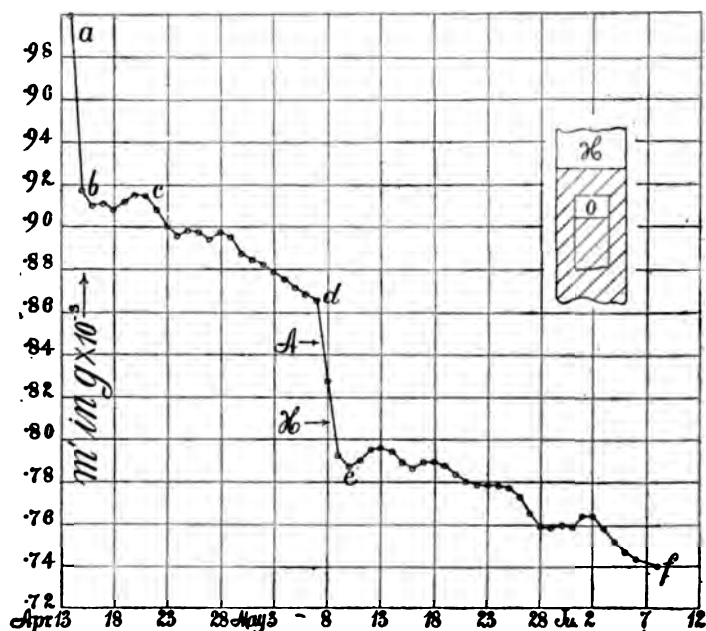

FIG. 9.—Chart showing loss of mass of gas in diver in lapse of days. Diffusion of oxygen into hydrogen.

The period of recovery, however, is characterized by an entirely new rate, viz,

$$-\dot{m} = 18 \times 10^{-6} \text{ g/day}$$

only a little more than one-half the preceding rate. Hence

$$\kappa = 0.44 \times 10^{-10}$$

In other words, the new rate corresponds to a diffusion of three gases, hydrogen, oxygen, and nitrogen, and is characteristic of this mixture. The coefficient is the smallest observed, but the final period of steady diffusion has not yet been reached.

23. **Transpiration of Hydrogen into Air Through Water.**—These experiments, given in table 7 and fig. 10, are a sustained repetition of the work in §11, using a much heavier swimmer, so that a decrease of the area of diffusion due to loss of gas by transpiration may not occur. The curve, as before, is remarkably regular and partakes of the qualities of the earlier curve (fig. 5). The initial rate is $-m = 71 \times 10^{-6}$ g/day or 8.2×10^{-13} g/sec., which is of the same order as the datum of table 2, remembering that the constants of the apparatus are slightly different. The coefficients of transpiration are, since $\sigma = 11.5$ cm.² (inside area),

$$h'' = 11.5 \text{ cm.} \quad 2h''' = 9.0 \text{ cm.} \quad l = 20.5 \text{ cm.}$$

and, if the water heads be taken as a trial gradient for comparison, so that

$$\frac{dp}{dl} = 549 \text{ dynes/cm.} \quad k = 1.3 \times 10^{-13} \quad \kappa = 16 \times 10^{-10}$$

somewhat larger than the above datum ($k = 1.1 \times 10^{-13}$), the difference, however, being of the same order as the irregularities of the sectional areas of the diffusion columns and referable, in part, to the values of h'' and h''' involved. There is, furthermore, a difference in the mean of the irregular temperatures. Close agreement, therefore, was not to be looked for.

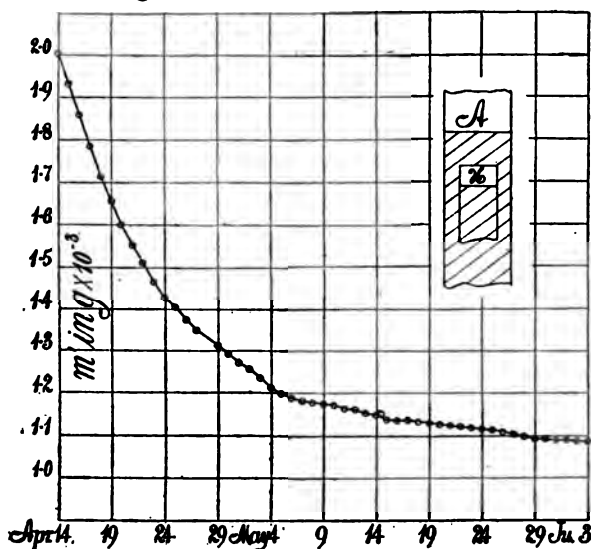

FIG. 10.—Chart showing loss of mass of gas in diver in lapse of days. Diffusion of hydrogen into air.

The final coefficients are largely subject to the water heads under which diffusion takes place. We may therefore write, since

$$-m = 3.5 \times 10^{-6} \text{ g/day or } 4.0 \times 10^{-11} \text{ g/sec.} \quad k = 0.64 \times 10^{-14}$$

and from this

$$\kappa = 0.78 \times 10^{-10}$$

which approaches the coefficient for air (0.91×10^{-10}), as would be anticipated. One may note, however, that it is nevertheless still below it.

TABLE 7.—Diffusion of hydrogen through water into air. Heavy swimmer, $M=37.42$; $R_h=41.45 \times 10^6$; $\rho_m=13.6$; $1/\rho_g=0.3486$;* $A=Mg\rho_m/R_h=0.01205$; $h'=1.8$ cm.; $h''=11.5$ cm.; $h'''=4.5$ cm.; $l=20.5$ cm. Areas, inside 11.5 cm.², outside 13.5 cm.², ring $24.6-13.5=11.1$ cm.²; $\rho_h=89.55 \times 10^{-3}$. Diameters 3.83, 4.15, 5.6 cm.; correction 0.13 cm. Hg.

Date.	Hour.	Barom-eter.	H	l	$m \times 10^6$	Date.	Hour.	Barom-eter.	H	l	$m \times 10^6$
	<i>h. m.</i>			°			<i>h. m.</i>			°	
Apr. 14	5 00	76.26	74.00	17.4	2007	May 10	4 00	75.32	43.71	21.2	1171
15	3 00	75.81	71.86	19.7	1935	11	4 00	75.69	43.48	21.6	1164
16	3 30	75.25	68.92	18.8	1861	12	4 00	75.90	43.37	21.5	1161
17	3 30	75.45	65.96	17.9	1786	13	4 30	75.92	43.10	22.0	1152
18	4 00	75.67	63.44	18.3	1715	14	4 30	76.81	42.75	20.6	1148
19	4 00	75.69	61.02	16.9	1657	15	4 00	76.14	42.28	20.2	1137
20	3 45	75.10	58.82	16.2	1601	16	4 00	75.74	42.45	21.9	1135
21	4 00	75.50	57.21	16.8	1554	17	4 00	75.93	42.44	21.9	1135
22	4 00	76.14	55.64	16.7	1512	18	4 00	75.32	42.22	21.1	1132
23	4 00	76.37	53.81	16.1	1465	19	4 00	75.86	42.13	21.6	1128
24	4 00	76.02	52.65	17.4	1428	20	4 00	76.08	42.15	22.5	1125
25	4 00	76.26	51.94	18.5	1404	21	4 30	76.09	42.09	21.9	1123
26	3 30	76.82	50.82	18.4	1374	22	4 00	75.82	41.97	22.4	1121
27	3 15	76.88	50.09	19.7	1349	23	4 00	76.40	41.98	23.1	1118
28	3 15	76.33	48.52	20.8	1302	24	4 00	76.11	41.79	22.6	1115
29	4 00	75.77	49.01	21.2	1313	25	4 00	75.69	41.81	23.3	1113
30	4 00	75.58	48.02	19.7	1293	26	4 00	75.96	41.64	23.1	1109
May 1	3 45	75.02	47.31	20.2	1272	27	4 00	76.22	41.31	22.5	1103
2	4 00	74.91	46.71	20.0	1257	28	4 30	76.20	41.14	22.6	1098
3	4 00	75.71	45.78	19.0	1235	29	4 00	75.95	40.82	21.5	1093
4	4 15	76.14	44.96	19.0	1213	30	4 00	76.22	40.73	21.1	1092
5	4 00	76.35	44.33	18.2	1199	31	3 30	75.91	40.66	21.6	1088
6	4 00	76.48	44.03	18.8	1189	June 1	4 00	76.96	40.88	23.2	1089
7	4 30	76.06	43.85	19.0	1183	2	5 00	75.55	40.80	23.2	1087
8	4 00	75.93	43.83	20.2	1178	3	3 15	76.25	40.56	21.9	1085
9	4 00	74.95	43.85	21.1	1175						

*Cf. § 24.

24. Correction for Density of the Glass.—The provisional value of $1/\rho_g$ admitted in tables 2, 3, 4, 5, 6, and 7 when the divers were engaged, viz, $1/\rho_g=0.3486$, was inadvertently chosen too small; *i. e.*, the density was overestimated. Experiments made by Miss L. C. Brant at the end of the work, when the divers were available, showed the values given in table 8, the divers being recognized by the weights *m*.

TABLE 8.

No.	<i>m</i>	ρ_g	Used in table.
A.....	12.0114	2.4840	3, 6
B.....	37.4248	2.4701	7
C.....	14.4481	2.4873	5
D.....	18.0962	2.4219	2, 4

It suffices for the present purposes of correction to take the mean value $\rho_g=2.466$, so that the error is $\delta\rho_g=-0.402$.

If we differentiate the equation

$$m = A \frac{H}{\tau} \left(\frac{1}{\rho_w} - \frac{1}{\rho_g} \right)$$

logarithmically, with respect to ρ_g , the result is

$$\frac{\rho_w}{\rho_g(\rho_g - \rho_w)}$$

and since $k = \dot{m}/a(dp/dl)$, the same relative error will occur in m , \dot{m} , v , \dot{v} , k , and κ . Since $\rho_w = 1$ (nearly) and the assumed value of $\rho_g = 2.868$ and $\delta\rho_g = -0.402$, this correction is

$$\frac{-0.402}{2.868(1.868)} = -0.075$$

Unfortunately the error $\delta\rho_g$ is too large to admit of differentiation. The correction for m may, however, also be given directly by multiplying by

$$\frac{1/\rho_w - 1/\rho_g'}{1/\rho_w - 1/\rho_g}$$

where the numerator contains the correct values. In this way, for the mean temperature of observation, the fraction is

$$\frac{0.5974}{0.6544} = 1 - 0.0871$$

or the correction is -8.7 per cent. It will therefore be necessary to reduce all the values specified by this amount. It is needless to apply the correction to the above tables, since their chief purpose was to show the character of the variation of m in the lapse of time, and all temperature corrections, etc., have there been made. But in table 9 of the next section, which is a summary of essential results, the correction has been introduced in full. The final data are therefore smaller than the above.

25. Summary. Relatively Slow Diffusion of Mixed Gases.—The data of the preceding tables have been brought together in all their essential features in table 9, values in parenthesis being nominal, due to the variable gas constant, R , involved. In case of mixed gases the initial diffusion is simply tabulated for comparison and the gradient selected (water heads h'') merely furnished a means of obtaining a datum (k or κ in parenthesis), independent of the dimensions, etc., of the apparatus. In these cases (k) or (κ) have no immediate meaning, because the diffusion is differential under conditions which have not been disentangled. The data, like \dot{m} , which is not free from the constants of the apparatus, merely indicate the enormously rapid diffusion at the outset, while the potential energy of separated gases is being expended. In case of mixed gases \dot{m} also is nominal, the true datum being \dot{v} , the number of cubic centimeters diffusing per second as explained above.

TABLE 9.—Summary. Initially both gases diffuse; finally the free gas, or gas without, diffuses in the nearly pure state.

Gases.		$m \times 10^{10}$ g./sec.	Corrected $M \times 10^{10}$ K./sec.	$p \times 10^6$ cm. ³ /sec.	Corrected $P \times 10^6$ cm. ³ /sec.	$P \times 10^{10}$ By mass.	Corrected $P \times 10^6$ By mass.	$K \times 10^6$ By volume.	Corrected $K \times 10^6$ By volume.	From table.	Remarks.	
Within or below.	Without or above.										Rate.	Gradient.
Air.....	Air.....	- 4.04	- 3.69	0.034	0.031	1.09	1.00	0.91	0.83	3	Total.	
Hydrogen.	Hydrogen.	- 1.13	- 1.03	.137	.125	.192	.175	2.14	1.95	4	Total.	
Hydrogen.	Air.....	(- 6.3)	(- 5.8)	.767	.700	(1.07)	(.98)	(13.0)	(11.9)	2	Initial.	Water head only.
		(- 6.3)	(- 5.8)	.767	.700	(.0115)	(.0105)	(.14)	(.128)	2	Initial.	Barometric pressure.
		(- 8.2)	(- 7.5)	.996	.909	(1.30)	(1.19)	(16.0)	(14.6)	7	Initial.	Water head only.
		(- .40)	(- .37)	.049	.045	(.064)	(.058)	(.78)	(.71)	7	Final.	Water head only.
Air.....	Hydrogen.	(+64.0)	(+58.0)	.533	.487	5	
		(- 18.0)	(- 16.4)	.150	.137	(6.0)	(5.5)	4.9	4.5	5	Final (1)	Water head only.
		(- 5.9)	(- 5.4)	.049	.045	1.6	1.5	5	Final (2)	Water head only.
		(- 3.0)	(- 2.7)	.025	.023	(.97)	(.89)	.81*	(.74)	5	Final (3)	Water head only.
Oxygen....	Hydrogen.	(- 95.0)	(- 86.7)	.715	.653	6	Initial.	
		(- 3.7)	(- 3.4)	.028	.026	(1.04)	(.95)	.78	.71	6	Final (1)	Water head only.
		(- 2.1)	(- 1.9)	.016	.01544*	.40)	6	Final (2)	Water head only.

*After accident.

The case of hydrogen, diffusing into air, does not show large values in \dot{m} ; this might seem to be due to an even more rapid diffusion during the first day, decaying more rapidly. It is, however, at once interpreted on reducing \dot{m} to \dot{v} , the diffusion relative to volume (see table 9).

The initial diffusion of hydrogen out of the swimmer into air, and of hydrogen into the swimmer containing air, is in excess of the opposed current of air, by an amount of about the same order. The rate at which imprisoned hydrogen escapes from the swimmer in excess of the entrance of air is, however, definitely larger than the excess of rate of entry, compared with the escape of air in the converse case, for reasons which do not at once appear. These rates are $\dot{v} \times 10^6 = 8$ to 10 for escaping hydrogen, and $\dot{v} \times 10^6 = 5$ for entering hydrogen, and are to be somewhat modified by the constants of the apparatus. Possibly the fact that the water must first be saturated with hydrogen before this gas can enter the swimmer, whereas it escapes with greater freedom into unsaturated water, accounts for this initial difference. At the same time, hydrogen enters the swimmer *against* the pressure gradient of the water levels.

In general, however, the diffusion of mixed gases, during the first day, is in need of more detailed investigation, in which case special methods of charging and of observing *without removing the artificial atmosphere*, will have to be devised, as is done in the last chapter.

The special feature of table 9 is the relatively low rate of the final diffusion of mixed gases. Thus the mixture air-hydrogen (table 8), which is nearly all air, shows a lower rate than pure air; the final hydrogen-air diffusion, which is nearly all hydrogen, a lower rate than pure hydrogen; the final hydrogen-oxygen diffusion, a much lower rate than pure hydrogen; the hydrogen-oxygen-nitrogen diffusion, which is nearly all hydrogen, a much lower rate than air or hydrogen, etc. It seems, therefore, that small quantities of a second gas added to the pure gas markedly reduce its rate of diffusion, κ . The reason of this would seem to be the potential energy of the mixture, which must here be increased to the potential energy of separated gases. Thus the opportunity of dissipating potential energy is decreased and the diffusion is correspondingly sluggish.

It is, however, probably sufficient to refer the whole question to the actual value of the full pressure gradients involved. If p_a, p_b, p_c, \dots , are the partial pressures of the gases within the swimmer, when B is the barometric pressure and $h''\rho_w g$ the pressure due to the heads of water bearing on the gas mixture and π the vapor pressure,

$$p_a + p_b + p_c + \dots = B - \pi + h''\rho_w g$$

Hence if the pressure $B - \pi$ is due to the gas a (artificial atmosphere), it will enter the swimmer if

$$p_b + p_c + \dots > h''\rho_w g$$

it can not escape from the swimmer until $p_b + p_c + \dots = h''\rho_w g$. As this is a small pressure, the gases b, c, \dots must themselves escape slowly,

and consequently the gas a , with the diminution of $p_b + p_c + \dots$ will also escape slowly. As a whole the results contain a remarkably striking commentary on the meaning and potency of the pressure gradient. To develop an equation, however, which embodies all these facts, in such a way as to predict the observations quantitatively, has not been accomplished in the above paper. In fact, if we write

$$\dot{m} = \rho\dot{v} + v\dot{\rho} = \rho\dot{v} + \dot{\rho} \frac{m_0 + \int \dot{m} dt}{\rho}$$

where m_0 is the initial charge of pure gas, \dot{m} and \dot{v} are given in terms of ρ by equations (31) and (35). Hence the equation may be expressed in terms of ρ and becomes eventually

$$\frac{\ddot{\rho}}{\rho} (\rho\dot{v} - \dot{m}) - 2\dot{\rho}\dot{v} - (\rho\ddot{v} - \ddot{m}) = 0$$

TABLE 10.—Values of ρ (density) in the final diffusions of mixed gases. $B - \pi = 74$ cm.; $\Pi = 987,000 + p'$ dynes; $k_a = 1.09 \times 10^{-12}$; $k_b = 1.92 \times 10^{-14}$; $R_b/R_a = 14.44$.

$$\frac{\rho}{\rho_0} = \frac{R_b}{R_a} - \left(\frac{\dot{m}}{a} - k_a \frac{p'}{l} \right) \frac{l(R_b/R_a - 1)}{\Pi(k_a - k_b)}$$

	From table 7.	From table 5.
$\dot{m} \times 10^{10}$	0.40	5.9
$\rho_0 \times 10^6$	82	1,200
a	11.5	6.4
l	20.5	20.0
k''	11.5	10.0
p'	11,260	9,790
Π	998,500	997,100
ρ/ρ_0	14.27	0.0864
x	0.987 (air)	0.981 (hydr.)

Here \dot{v} and \dot{m} involve ρ , while \ddot{v} and \ddot{m} are proportional to $\dot{\rho}$. Moreover, the phenomenon expressed in terms of ρ , the density of the imprisoned gas, should be integrable, but the equation does not seem to reduce down sufficiently to make the attempt at integration worth while.

With regard to equations (31) or (35) it should be pointed out that when \dot{m} or \dot{v} is known, ρ may be computed in terms of the coefficients, k_a and k_b , of the two gases diffusing into each other. As in the final phases of the phenomenon \dot{m} is nearly constant, the density and hence the composition of the gas undergoing diffusion in one direction may be found with some precision. Thus in table 9 the air-hydrogen and hydrogen-air diffusions, when \dot{m} has become constant, correspond to mixed gases of the density and composition indicated in table 10.

The marked irregularities of the graphs in case of air and oxygen, when there are temperature variations, has been referred to the effect of solution, which absorbs a soluble gas at falling temperatures and rejects it at rising temperatures, contemporaneously with the occurrence of diffusion. It is

nearly absent in case of the diffusion of hydrogen and is thus not a direct temperature effect. To state the case analytically, the volume v of the imprisoned gas is, in terms of its gas constant R , absolute temperature τ , pressure p , and mass m , as usual given by

$$p = R \frac{m}{v} \tau = R \rho \tau$$

Now, since

$$m = \frac{H \rho_m g}{R \tau} M \left(\frac{1}{\rho_w} - \frac{1}{\rho_g} \right)$$

it follows that

$$v = m/\rho = \frac{H \rho_m g}{p} M \left(\frac{1}{\rho_w} - \frac{1}{\rho_g} \right)$$

where v is the volume which would be contained in the diver and ρ the corresponding density of the gas, at any selected fixed or fiducial atmospheric pressure and absolute temperature p and τ , under which the experiment is supposed to take place. If the latter be given in centimeters of mercury, the barometric height being B ,

$$p = B \rho_m g \quad v = \frac{H}{B} M \left(\frac{1}{\rho_w} - \frac{1}{\rho_g} \right)$$

It follows that if we divide m by ρ , the density of the gas originally in the diver under the specified normal conditions (density being known for a single gas but not at once given in case of a mixture), we refer all data to these conditions and temperature and pressure discrepancies are excluded. Moreover, v and the corresponding diffusion coefficient, $\kappa = v/a(dp/dl)$, can be computed for any gas, mixed or simple. Under the form $Bv/H + M/\rho_g = M/\rho_w$, the above volume equation is obvious directly, as the approximate condition of flotation at the manometric pressure H .

Finally, it is not improbable that the irregularities of graph in question may be actually used as a means of measuring the variation of the solubility of a gas in the liquid, with temperature.

In conclusion I may point out the extreme sensitiveness of the above method. With the same apparatus, relative data should be determinable with an accuracy comparable to that with which the barometer can be read; *i. e.*, much within 0.1 per cent, since, finally, $v = v'H/B$, where v' is the nearly constant volume on flotation. Absolute data, however, require a determination of the constants of the apparatus, which is less accurately feasible. It has already been intimated that to secure this sensitiveness, temperature must be kept constant in the lapse of time. Furthermore the rigorously pure gases must be introduced under their own atmospheres and there must be no foreign gases dissolved in the liquid. Moreover, all observations must be made with the artificial atmosphere kept in place. Indeed, it is a question whether the effect of diffusion in rendering gases stored over water impure has generally been adequately guarded against.

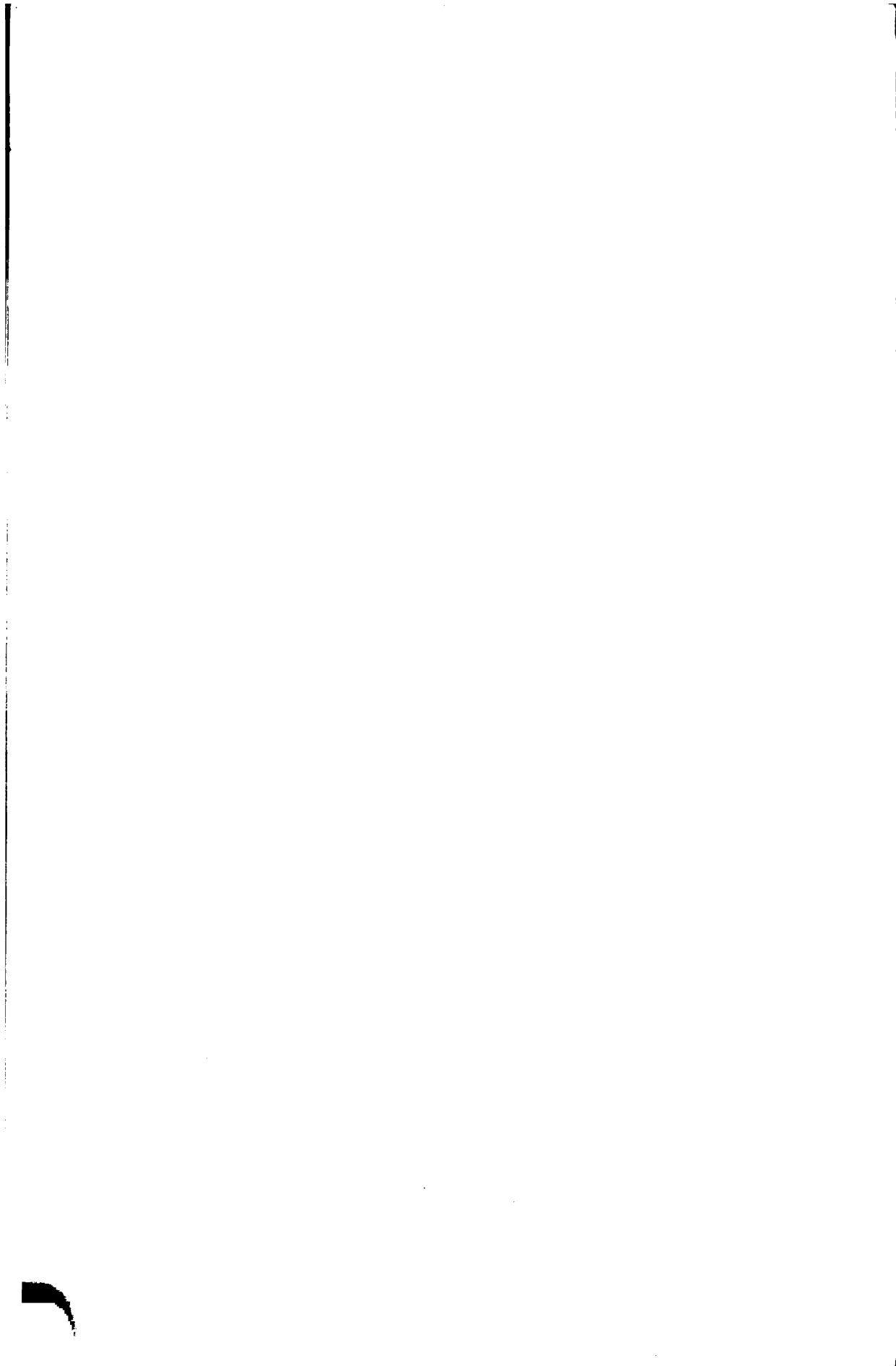

CHAPTER III.

HYDROSTATIC METHODS FOR THE ABSOLUTE ELECTROMETRY OF HIGH POTENTIALS.

PART I.—HYDROMETER METHODS.

26. Introduction.—The remarkable precision of weight measurement, which was shown in case of the experiments with the Cartesian diver discussed in the above chapters, suggested experiments along similar lines for purposes where other forces (electrical forces, for instance) are in question. It will be necessary in the course of the present work to measure very high potentials. Hence the modification of the absolute electrometer in such a way that the movable disk is supported by a hydrometer, or by a Cartesian diver, floating in insulating liquids under known conditions, seemed to be an interesting application. In fact, the direct test of the consequences of Coulomb's law, for the case in which the movable conductor is a Cartesian diver, is well worth the trial.

27. Absolute Electrometer.—The first experiments were made by the hydrometer method, and figs. 11, 12, 13 show the apparatus. In fig. 11 A *ccded* is the condenser, *dd* being the guard ring and *e* the movable disk, both being flanged on the circular edges toward each other, for stiffness. The plate *cc* is supported by the screw *ss* passing through the lateral arm of hard rubber *b*. The hard-rubber handle *a* rotates the screw *ss* and plate *cc* around the vertical axis, so that it may be brought in contact with *dd* or removed from it by as much as may be desirable. The complete and partial turns of *ss* are given by a graduated head (not shown) as in case of the ordinary micrometer caliper. In this way the distance apart *D* of the plates *cc* and *dd* is sharply determinable.

In certain of the measurements below it is desirable to be able to raise the guard ring from its position in the uncharged apparatus to the level of the disk. It should therefore be adjustable in the vertical direction.

The guard ring *dd* is the top of a box and is perforated at its bottom with a brass tube *ggg*, 35 to 40 cm. long, closed by the plug *k*. The T-coupling *h* communicates at *i* with a water reservoir for floating the hydrometer, the top of which is the disk *e*.

In fig. 11 A the float is a very thin tube of aluminum *ff* about 0.854 cm. in diameter and nearly 30 cm. long. It is closed above and below and there prolonged by a thin stiff wire *m* about 7 cm. long, terminating in the brass sinker *n*. The whole arrangement *efmn* weighs about 15 grams and floats with the tube vertical and disk horizontal in the charge of water *ww*. This float is very mobile in the vertical direction, so that if electrical forces are strong enough it may actually be lifted into contact with the disk *cc*. One of the methods of measurement presently to be given will depend upon this possibility.

To keep the water level at the proper height or to raise or lower it by a definite amount, the screw pump in fig. 13 is available. This consists essentially of a thick screw S playing into the brass tube cc , which is closed at the top by the stuffing box a compressing the ring of soft material bb . The bottom of the tube cc ends in the tubulure i , to be joined by appropriate tubing with the corresponding tubulure i in fig. 11A. The brass tube cc , fig. 13, is quite filled with water to the exclusion of air, so that every turn of the screw S raises the level ww in fig. 11A by a definite amount. The screw S is also provided with a graduated head (not shown), so that the whole turns and fractions of a turn may be read off, and the ratio of the diameter of the water level in fig. 11A and that of the screw S in fig. 13 must be known. In the figure the ratio of the areas is about ten to one.

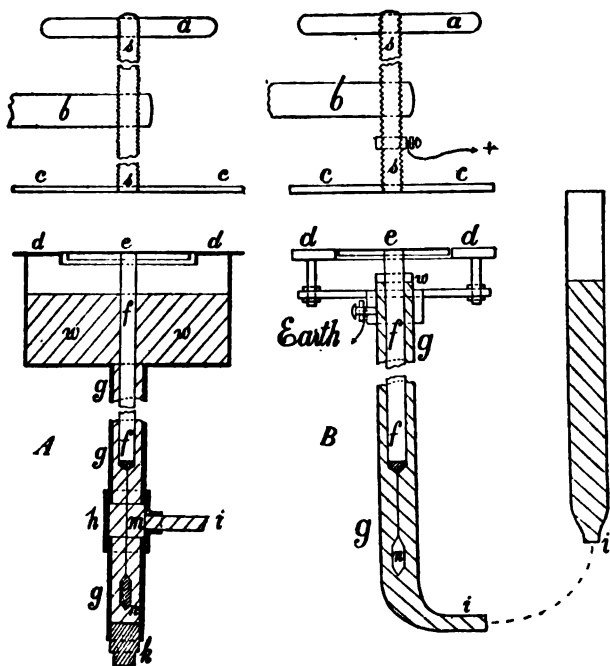

FIG. 11 A.—Absolute electrometer with disk carried by tubular hydrometer of aluminum.
B.—Absolute electrometer with glass U-tube for adjusting levels.

It is interesting to note in passing that on sudden advance or retreat of the screw S an impulsive wave passes through the liquid, suddenly raising and lowering the disk e often more than a centimeter and with considerable force. Direct and reflected waves are recorded in this way.

In many of the experiments it was found sufficient to coat the screw (hot) with an adhesive layer of resin and beeswax. A well-fitting brass screw 0.75 inch in diameter and 20 threads to the inch was used. A socket of indurated fiber is even preferable, there being no appreciable leakage for some time. This avoids the complication of a stuffing box, but of course it

will not last indefinitely. In other experiments the hose *ii* was branched and led to a glass reservoir, showing the water level on the U-tube principle. In such a case the water level *w* could be read off at the reservoir, by a cathetometer or some equivalent simpler attachment.

In the latest form of apparatus the guard-ring cup holding the water at *w* was dispensed with and replaced by the prolonged tube *g* (now made of glass) as shown in fig. 11 B. Here *gg* is the glass tube 0.75 to 1 inch in diameter communicating with the hose *i* below and holding the float *f* submerged as far as the water level *w*. The advantage of this form is this, that all parts of the floating tube may be seen and the floating level read off at *v*, for instance. It is necessary, however, to keep the tube in the middle of the water level, at *w*, by aid of three *horizontal* adjustment screws (not shown), at a horizontal angle of 120° , surrounding the tube *ff* very loosely. In such a case the disk *e* is kept centered, the tube *f* is never in contact with *gg*, and a little tapping obviates all danger of friction.

Fig. 11 B also shows the level controlled by a tubular glass receiver *hh* with its water level visible at *w'*. This is to be held on a vertical slide micrometer, so that the shift of *hh*, due to a charge on *cc*, may be accurately read. In fact, this form of instrument, requiring no subsidiary apparatus, was finally adopted throughout. The vertical slide *h* need only be a few centimeters long and provided with a moving vernier for a fixed scale.

For potentials higher than 20,000 or 30,000 volts, the vertical height of the space *cd* must be much increased, to prevent the continuous rise of the disk *ee*. Hence the guard ring should be much larger than in the figure or the disk appreciably smaller. Furthermore, in this case the sharp screw *ss* and similar sharp edges elsewhere as in the disks *cc*, *dd*, etc., are inadmissible. Without rounded edges and a rounded screw, the secondary disturbances due to electric winds interfere with the interpretation of the measurements and the apparatus will not take a high potential. All parts except the disk *cc* are of course put to earth, and possible induction between *cc* and other conductors except *dd* must be scrupulously guarded against.

Finally, fig. 12 shows an alternative float consisting of the disk *e* corresponding to fig. 11 A, the tube *ff* passing the preferably conical capsule *pp* about 1.5 cm. high and 5 cm. in diameter, of thin brass hermetically sealed. The tube *ff* is prolonged below by the solid brass rod *n* or sinker. When placed in the cup, fig. 11 A, or in a similar vessel, the water level is at *ww* and may be adjusted by dropping small weights down the tube *ff*. The same method, fig. 13, is used for placing this level. The whole arrangement

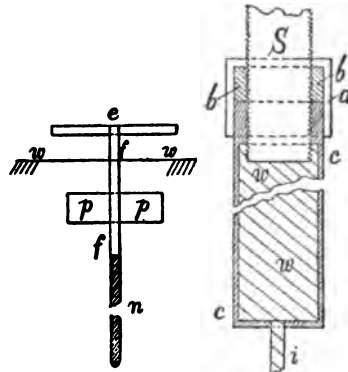

FIG. 12.—Hydro-meter and disk carried by air-chamber.

FIG. 13.—Compression screw for adjusting levels.

weighs about 35 grams, including disk and sinker. The essential part is the tube *ff* of copper about 0.5 cm. in diameter. This float is not intended to rise and fall as in the case of fig. 11A, but to move to a definite level under the influence of the electrical forces of the condenser.

Water has been referred to as the liquid charge of the apparatus. It has an advantage, inasmuch as the whole of the lower half of the condenser may be earthed and the guard ring and disk are necessarily at the same potential. It has the very serious disadvantage, however, that large capillary forces are involved, particularly in case of the wide stem of fig. 11A. Hence a charge of kerosene oil or even of the heavier clear paraffin oil is preferable.

In cases where the disk *e* in its uncharged position is to be flush with the surface *dd*, it is convenient to provide the tube *gg* with opposite glass windows (not shown), through which a mark on the tube *ff* or the bottom of the tube or the sinker may be distinctly seen. The adjustment is made once for all, so that when *e* is flush with *d*, the mark seen at the window may coincide with a definite line or two lines in the same horizontal plane on the opposed windows.

28. Equations for the Tubular Float.—Let *V* be the difference of potential of the plates of the condenser in the absolute electrometer and *D* their distance apart. Let *F* be the electric field, so that $F = V/D$. Furthermore let f_e be the electric pressure between the plates, *i. e.*, the pull per square centimeter.

Suppose the disk *e* is raised a small distance *l* above the level just characterized by *D*. Then we may write, since $8\pi(300)^2 = 2.262 \times 10^6$

$$f_e = V^2 / 2.262 \times 10^6 \times (D-l)^2 \quad (1)$$

if *V* is given in volts.

The total mechanical force evoked by the same rise *l* above the position of equilibrium of the float is $v\rho g$, where *v* is the volume of the stem submerged, ρ the density of the liquid, and *g* the acceleration of gravity. Let *r* be the radius of the stem (*ff*, fig. 11A), and *R* the radius of the disk (*e*, fig. 11A). Then the amount of force evoked per square centimeter of the disk, *i. e.*, the mechanical or restoring pressure f_m , is

$$f_m = \frac{r^2}{R^2} l\rho g \quad (2)$$

In the case of equilibrium these two pressures are equal, $f_e = f_m$, and therefore

$$V^2 = 2.262 \times 10^6 \left(\frac{r^2}{R^2} \right) \rho g (D-l)^2 l \quad (3)$$

To measure *V*, therefore, both *D*, the original distance apart of the uncharged plates of the condenser (disk flush with the level of the guard ring) and the rise of the disk, *l*, on charging, must be known. It will also be desirable to raise the guard ring to the level of the disk in the charged apparatus.

Since equation (2) is linear in l and equation (1) quadratic in l , the curves of f_e and f_m in terms of l must in general intersect in two points, one of which (lower or smaller l) corresponds to stable and the other (upper or larger l) to unstable equilibrium of the disk. For a fixed value of D these are further apart as V is smaller. When V increases sufficiently the two points of intersection eventually coalesce in a single point. This particular value of l shows the highest stable position which the disk may reach. For large values of V there is no point of intersection, or the disk passes without interruption from the lower to the upper plate of the condenser. The same result may be brought about by decreasing D for a fixed V , and on this principle I have based the following method of measurement.

If we differentiate equations (1) and (2) with respect to l the results are

$$\frac{df_e}{dl} = \frac{2V^2}{2.262 \times 10^6 (D-l)^2} \quad (4)$$

$$\frac{df_m}{dl} = \frac{r^2}{R^2} \rho g \quad (5)$$

If these slopes are identical

$$V^2 = \frac{1}{2} 2.262 \times 10^6 \frac{r^2}{R^2} \rho g (D-l)^2 \quad (6)$$

Now, when there is but a single point of intersection (tangency of equations (1) and (2)), equations (3) and (6) correspond to the same value of $l=l_e$, whence after canceling superfluous quantities

$$D = 3l_e \quad (7)$$

In other words, if the electrical forces are sufficiently strong to raise the disk e more than one-third of the distance D between the plates of the condenser, it will pass all the way to the upper disk cc . Hence under these circumstances equation (3) gives

$$V^2 = 0.5027 \times 10^6 r^2 D^2 / R^2 \quad (8)$$

Thus in case of the first method of measurement the upper plate cc , fig. 11 A, is to be gradually lowered, while the disk e rises, until the last position of stable equilibrium is just exceeded, or the disk travels to the upper plate. The guard ring may now be raised $D/3$ and a closer adjustment made.

29. Constants of the Tubular Float.—To show the numerical relations involved, the values of f_m and f_e may be computed and represented graphically in terms of the lift l . Since for water $\rho=1$, and the diameters of stem and disk are 0.854 cm. and 6.65 cm., respectively,

$$f_m = \frac{r^2}{R^2} \rho g l = 16.18l \text{ dynes}$$

which is the oblique line through the origin of the graph in fig. 14.

To compute f_s , a suitable value of D and V must be assumed. Let $D=4$ cm. and V in succession 10^4 , $10^4 \times 1.41$, $10^4 \times 1.86$, $10^4 \times 2$ volts. Since

$$f_s = V^2 / 2.262 \times 10^6 (4-l)^2$$

the successive curvilinear lines of the diagram are obtained. The lowest have two intersections each; the one corresponding to stability being at s and the unstable one at us . For at s , a lowering of the disk means an excessive upward electric force, while any rise of the disk means an excessive downward and mechanical force. Just the reverse is true at us . The two upper curves have one contact and no contacts, respectively. Hence, when

$V=10^4 \times 1.86$ and $D=4$, the disk will just be on the point of rising without interruption. The maximum rise compatible with stability would be $4/3$ cm. The rise for $V=10^4$ and $10^4 \times 1.41$ would be roughly 0.18 and 0.43 cm., respectively.

To compute the potential of the maximum point of stability for $D=3l=4$, equation (3) becomes

$$V^2 = 2.262 \times 10^6 \frac{r^2}{R^2} \rho g \frac{4}{27} D^3 = 1.86 \times 10^4 \text{ volts.}$$

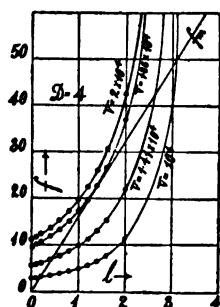

FIG. 14.—Chart showing the forces actuating disk for different potential differences and displacements of disk.

The values of l for the stable positions of the disk in case of different values of D and V are not so easily found, in view of the cubic equation (3). When l is very small, however, *i. e.*, for values of V less than 10^4 volts, l may be neglected in comparison

with D and the equation becomes

$$V^2 = 2.262 \times 10^6 \frac{r^2}{R^2} \rho g D^3 l \quad (9)$$

Hence, if $V=10^3$ the disk would only rise about 0.018 centimeter. For $V=10^2$ to 0.00018 cm., etc., so that even the interferometer could not indicate more than about 10 volts. If, however, D is also reduced, say to 0.5 cm., or 8 times, the rise will be $l=0.000092$ cm. per volt; for $D=0.1$ cm., $l=0.00115$ cm., etc.

Hence with the use of the interferometer and small values of D , there is no reason why ultimately single volts should escape measurement except for the capillary forces involved in flotation, where the stem penetrates the liquid, as in case of the above apparatus. By decreasing the diameter of the stem, however, as in the float fig. 12, sensitiveness may be further increased.

30. Constants of the Conical Float (Capsule).—When the float is of the form given in fig. 12 and a suitable window is provided in the tube gg , fig. 11A, or other vessel, so that the zero position (disk e flush with the guard ring dd) may be accurately determined by lens or telescope, another

method of measurement may be tested. In this case D is to be the same for the charged and the uncharged state, *i. e.*, to be constant, while the water level ww is lowered in fig. 11A by a definite amount of rotation of the screw in fig. 13. Hence equation (3) becomes

$$V^2 = 2.262 \times 10^6 \frac{r^2}{R^2} \rho g l D^2 \quad (10)$$

where l is the drop of the water level due to the play of the screw S in fig. 13. If $2R'$ is the diameter of the water level ww , in the cup, fig. 11A, and $2R''$ the effective diameter of the screw (diameter of the solid cylinder plus the thickness of the thread), and L its longitudinal displacement, equation (10) becomes

$$V^2 = 2.262 \times 10^6 \left(\frac{r R''}{R R'} \right)^2 \rho g L D^2$$

If, therefore, $(R''/R')^2$ is small, say 0.1, the apparatus is correspondingly more sensitive, a result which is further enhanced by making $(r/R)^2$ small, *i. e.*, using a smaller stem and larger disk.

In case of the given float actually constructed

$$2r = 0.605 \text{ cm.} \quad 2R = 6.65 \text{ cm.} \quad 2R' = 8.23 \text{ cm.} \quad 2R'' = 1.803 \text{ cm.}$$

so that for water

$$V^2 = 2.262 \times 10^6 \left(\frac{0.605 \times 1.803}{6.65 \times 8.23} \right)^2 981 D^2 L = 0.879 \times 10^6 D^2 L$$

31. Experiments with the Tubular Float.—Experiments with a tubular float, chiefly in the form fig. 11B, were made at considerable length, but only a few results need here be recorded. With the apparatus as shown it was not convenient to go above 30,000 volts, and even with this voltage the inconstancy of the electrical machine was an ever-present annoyance. The chief purpose of the table, therefore, is to show the relative values of l , the depression of the water level for a distance apart D of the disks of the condenser, when the upper disk was at a potential of V and the lower at a potential zero.

The measurements as a whole proceeded smoothly, the only difficulty being the control of the electrical machine. The endeavor to increase the potential of the electrometer above 35,000 volts did not succeed, while with the appearance of brush discharge potentials fluctuated enormously at once. When the machine works smoothly, however, the disk takes a stable position for a sufficiently large D and may then be brought flush with the surface (by lowering the water level) without difficulty. Care must be taken to keep the centering screws above the water level (w in fig. 11B) quite dry. A little tapping is essential.

In all the above experiments $3l$ was much less than D , so that the disk rose to a position of stable equilibrium below the point at which continuous motion from the bottom to the top plate would have occurred. Only in

the last case of the second series for the case of the metal tube was the limit of stable equilibrium approached. When the potential is unsteady it is necessary to keep the disk some distance below this. For the case of the large values of V the guard ring should have been larger, but the results as a whole betray no discrepancy attributable to this effect. To detect it, facilities for constant potentials of the degree stated would have to be available. In conclusion, the simplicity of the apparatus as a whole deserves remark.

TABLE 11.—Measurements of potential, $V^2 = 2.26 \times 10^6 \rho g (r^2/R^2) l D^2$; $\rho = 1$; $2r = 0.854$ cm. $2R = 6.65$ cm. Al tube 30 cm. long; weight, 15 grams.

	l	D	$10^{-1}V$	l	D	$10^{-1}V$
I. Apparatus, figure 11 A.....	0.55	3.81	17.2	0.62	3.81	18.2
	.56	3.81	17.3	.79	3.81	20.5
	.72	3.56	18.3	.82	4.05	22.2
	.90	3.56	20.5	.72	4.05	20.8
II. Apparatus, figure 11 B..... Metal tube.	.47	5.08	21.1	.44	5.08	20.4
	.49	5.08	21.6	1.06	3.81	23.8
	.165	6.35	15.6			
III. Apparatus, figure 11 B..... Glass tube.	.22	4.83	13.7	.42	4.06	15.9
	.24	4.83	14.3	.31	5.08	17.1
	.35	4.57	16.4	.38	5.33	20.0
	.34	4.32	15.3	.43	5.59	22.2
	.48	4.06	17.0	.38	5.59	20.9
	.46	3.81	15.6	.48	5.84	24.5
	.67	3.56	17.6	.53	6.10	26.9
	.58	3.30	15.2	.40	6.60	25.3
	.62	3.30	15.7	.30	7.11	23.6
	.32	5.08	17.4	.27	7.62	24.0
	.40	5.08	19.4	.22	8.13	23.1
	.38	4.83	18.0	.16	8.64	20.9
.42	4.83	18.9	.16	9.14	22.1	
.38	4.57	17.0	.10	10.16	19.4	
.44	4.32	17.3				
IV. Apparatus, figure 11 B. Glass tube. Large electrical machine.	.70	6.35	32.1	.40	8.89	34.0
	.59	7.62	35.4	.11	10.16	20.4
	.42	8.89	34.8	.19	10.16	26.8

PART II. ABSOLUTE ELECTROMETRY BY AID OF THE CARTESIAN DIVER.

32. Introductory.—In the above methods the stem between the floats and the movable disk of the condenser passed through the surface of the liquid. This introduces capillary forces which are annoying and liable to be of serious magnitude. To obtain the utmost sensitiveness available, the stem must be discarded and the movable disk in question mounted on a Cartesian diver—the whole apparatus, *i. e.*, both plates of the condenser and accessories, being submerged in a non-conducting clear paraffin oil. The remarkable delicacy in weighing, instanced in the above experiments on the diffusion of gases, contributes to the success of the present experiments.

33. Apparatus.—The construction of the apparatus is shown in fig. 15 in vertical section. Here $ff'f'$ is an inverted bell jar, with a ground edge at ff and a neck for a stopper at $f'f'$. This is closed with a brass lid, ee , and contains the charge of paraffin oil as far as the level ww . The plates of the condenser are shown at gg and $hssh$, hh being the guard ring and ss the movable disk. In order that $hssh$ may be nearly plane the inner circular edge of hh is turned as thin as possible (not shown). The plate gg is held by a rod aa (with a clamp screw on top), the latter fitting snugly into the hard-rubber cylinder, to which it may be fastened with a set screw. The cylinder bb is in turn held by a sleeve and set screw, axially and vertically at the center of the lid ee . Hence gg may be adjustably raised by any desirable amount, or lowered into contact with hh .

In another form of the apparatus the rod aa , holding the disk, may be replaced by a micrometer screw and stuffing box.

The disk, ss , is floated on the Cartesian diver k of very thin brass tubing, to which it is soldered. The level of the liquid within is shown at v . Four adjustable bent wires ll keep the float in position, concentric with the axis of the circular plates of the condenser, and also prevent its falling below a convenient level.

The guard ring hh is supported by four strips of copper nn snugly fitting the inside of the bell jar. These are braced by a ring of metal mm , to which the strips nn are soldered. They terminate at the top of the tube pp , which is the lower electrode of the condenser, the clamp being at r . The tube pp finally is held in place by the perforated cork qq , all parts fitting tightly. In a further improvement of this apparatus, the guard ring is adjustable, being placed on three leveling screws, respectively, rotating with three springs. The wires ll are also adjustable.

The lid, finally, is provided with the tubulure c in connection with the exhaust pump and a stop-cock d for the introduction of air, the tube p below being closed by a cock (not shown) when the apparatus is used.

The apparatus as a whole is held in a suitable standard, and the ground edge of the lid ee is clamped securely (air-tight) to the ground top of ff . All other joints are made air-tight by an appropriate cement, applied on the outside.

To adjust the apparatus it is first filled with oil, through pp , to the required level, the bell jar being placed neck upward for the purpose and

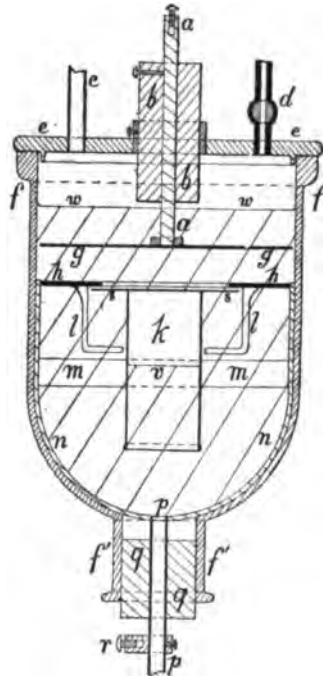

FIG. 15.—Absolute electrometer with disk carried on Cartesian diver.

c being closed. The jar is then inverted as in the figure, pp being closed. Air is now introduced through pp in small bubbles, which are caught within the Cartesian diver k , until the requisite amount of air is conveyed. During this operation it is expedient to connect the air pump at c (d being closed throughout) and to exhaust the air above w to the identical partial pressure subsequently to be used in the experiment. Air is then allowed to enter k through p , until the diver just floats. On closing p and restoring atmospheric pressure through k the diver will sink as far as its supports.

Clearly the diver will be in equilibrium at a higher artificial pressure in the air above ww when the condenser is charged than when it is uncharged, because of the attraction of electrical forces. This difference of pressure is the basis of the measurements.

In the course of the experiments it was found that means had to be provided to secure parallelism between the disks hh and gg of the condenser. This was done satisfactorily by placing hh on three suitable set screws, held at mm , together with three corresponding downward-tending springs. In such a case the disk hh , in the absence of the lid ee and the disk gg , may also be removed on loosening the springs, an operation frequently necessary, as, for instance, for the insertion of different divers k . The supports l are to be adjustable for this purpose.

In constructing the instrument for definite purposes a metal vessel $fff'f'$ should be used, provided with opposed plate-glass windows, through which the disk hh and the upper part of the diver may be seen during measurement in order that the time of drop may be ascertained. The disk hh would then be practically a horizontal partition in the vessel, though the disks should still be adjustable for parallelism. The pipe pp is to be soldered to the bottom for efflux of oil and influx of air. The form of apparatus given in fig. 15, however, sufficed very well for experimental purposes.

Since the guard ring and diver, the vessel, and lid are all put to earth, while the movable disk gg is charged, convection may be produced in the oil between the plates in case of high potential. Such a reaction on the disk of the diver may tend to modify the equilibrium and the amount of such an error will have to be shown by experiment; but nothing serious of the kind was detected. If a solid plate of mica or glass is interposed a variety of complications enter, which will be referred to below.

34. Equations.—If we return to equation (1), Chapter I, and neglect m/M , the ratio of the mass of the air contained in the Cartesian diver and the weight of the solid vessel (here of brass), in comparison with l ,

$$h + H \frac{\rho_m}{\rho_w} = \frac{Rm}{Mg} \frac{\tau}{1 - \rho_w/\rho_g} \quad (1)$$

where h is the difference between the level of the liquid within the diver and in the bell jar (vw , fig. 15), H the corrected pressure in centimeters of mercury of the artificial atmosphere above w , ρ_m , ρ_w , ρ_g , the densities of mercury, of the liquid floating the diver, and of the solid walls of the diver,

respectively, τ the absolute temperature, R the gas constant for air, and g the acceleration of gravity. This equation applies when the uncharged diver is just about to sink, or is instantaneously in unstable equilibrium.

If, now, other things remaining the same, the diver is charged to potential V , and D is the distance apart of the plates of the condenser, A the area of the movable disk, and f the electric pressure,

$$V = 300 D \sqrt{8\pi f} \tag{2}$$

where V is given in volts.

The effect of the charge is to keep the diver suspended, *i. e.*, to virtually reduce the weight Mg by fA . More water will have to enter to just float it. Hence H must be increased to H' , while h changes slightly. Hence

$$h' + H' \frac{\rho_m}{\rho_g} = \frac{Rm\tau}{(Mg - fA)(1 - \rho_w/\rho_g)} \tag{3}$$

It follows from equations (1) and (3) that

$$f = \frac{Mg}{A} \frac{(h' - h)\rho_w + (H' - H)\rho_m}{h'\rho_w + H'\rho_m} \tag{4}$$

As a rule $h' - h$, which refers only to the difference of level of the liquid in the diver, in the charged and uncharged states, may be neglected, and if R is the radius of the disk, $A = \pi R^2$, so that

$$f = \frac{Mg}{\pi R^2} \frac{H' - H}{H' + h\rho_w/\rho_m} \tag{5}$$

If this be substituted in equation (2) the result is finally

$$V = 300 \frac{D}{R} \sqrt{8Mg \frac{H' - H}{H' + h\rho_w/\rho_m}} \tag{6}$$

It is interesting to obtain an estimate of the numerical value of $H' - H$ for a diver which, when charged, floats at about atmospheric pressure. In the apparatus, fig. 15, M is about 35 grams and R about 3.5 centimeters. Hence

$$H' - H = 3.8 \times 10^{-8} V^2 / D^2 \tag{7}$$

and roughly the data given in table 12 apply, the numbers not defined being $H' - H$ in centimeters.

TABLE 12.

	$V = 10$	$V = 100$	$V = 1000$	$V = 10000$
$D = 0.01$ cm.	4×10^{-2}	4
$D = 0.1$ cm.	4×10^{-2}	4
$D = 1$ cm.	4×10^{-2}	4

With the disks of the condenser 1 mm. apart, it should therefore be possible to measure 50 volts, the difference of manometer pressure resulting being about 0.1 mm. of mercury. From this limit the manometer head rises rapidly as the square of V or inversely as the square of D . Thus for 50,000 volts and $D=1$ centimeter, $H'-H=100$ centimeters. Hence if measurements are to be made with the air pump, *i. e.*, with $H'-H$ less than the equivalent of one atmosphere, D will have to be increased to $D=2$ cm., where $H'-H=25$ cm., etc.

Practically the determination of V will depend upon the measurement $H'-H$ or of D . The latter seems to be the more convenient datum, though it requires a screw with graduated head and a stuffing box in place of the rod *aa* in fig. 15, *i. e.*, a screw micrometer for D . In such a case let $H'-H=36$ cm., a convenient mean value. In other words, the uncharged diver is to just float when the artificial atmosphere is about 36 cm. below the normal barometer, whereas the charged rider floats for different values of D . Hence by equation (7) for this typical case,

$$V = 3 \times 10^4 D \text{ volts, roughly}$$

or numerically

$D=0.01$	0.1	1.0	2.0 cm.
$V=300$	3,000	30,000	60,000 volts.

In other words, the electrometer, beginning with one electrostatic unit, will be suitable for measuring the ordinary sparking potentials in air of electrostatic and similar machines; for the distance apart of the plates of the submerged condenser would probably suffice to prevent sparking within. Moreover, $H'-H$ is large enough for accurate measurement.

35. Measurements.—For convenience the following experiments are made in terms of $H-H'$ the difference of manometer pressures. The potentials used were produced by a small Wimshurst machine, eventually kept in rotation by a small motor. The data are given in table 13, part I. Different values of H were used, as the apparatus was not quite tight below the rider, so that small accessions of air entered. The variations of V are probably due to the electrical machine, which was here turned by hand. The table shows a consistent series of relative values for V , notwithstanding the large variation given to D .

The diver was now modified by soldering it to a small sinker below in order to secure greater stability of vertical flotation. The results in table 13, part II, show considerable improvement and there was no leakage. Changes of V are again probably due to the electrical machine.

Another diver was now inserted having a breadth of tube somewhat larger than the above, being 5 cm. in diameter and 6 cm. long. Its mass was 31.98 grams, but unfortunately it proved to be slightly top-heavy in the lighter oil, so that only a few measurements were taken (table 13, part III).

The addition of a sinker increased the weight of the diver to 37.89 grams, the other constants being the same. The experiment was satisfactory

throughout, the suddenness with which the charged diver breaks off being specially marked. Care must be taken to decrease pressure slowly in order to avoid thermal discrepancies. Table 13, part IV, is an example of the data obtained.

TABLE 13.—Measurement of potential.

I.— $M=35$ grams. Disk, 3.5 cm. in diameter. Kerosene oil, $\rho=0.799$ at 24° . Barometer, 76.14 at 17° . Diameter of diver tube, 3.85 cm.; length, 8.8 cm.

D	H'	$H-H'$	$10^{-3}V$
cm.	cm.	cm.	volts.
0.32	57.9	9.5	5.90
.51	51.6	3.2	5.73
.63	50.3	2.1	5.81
.63	52.1	3.7	7.75
.63	53.2	5.0	8.72
1.27	48.0	.5	5.81

III.— $M=31.98$ grams. Diameter, $2R=5.0$ cm.; length, 6 cm.; slightly top-heavy.

D	H'	$H-H'$	$10^{-3}V$
cm.	cm.	cm.	volts.
1.27	59.75	9.53	22.0
1.27	62.20	10.45	22.9
1.27	60.72	8.80	22.0
1.27	61.62	9.42	21.7

II.— $M=35.795$ grams. Barometer, 75.70 at 19° . Diameter of diver tube, 3.85 cm.; length, 8.8 cm. $h\rho_w/\rho_m=0.3$.

D	H'	$H-H'$	$10^{-3}V$
cm.	cm.	cm.	volts.
1.016	38.48	0.44	5.6
1.016	52.91	.97	7.1
1.270	37.19	1.05	9.8

IV.— $M=37.89$ grams. Diameter, $2R=5.0$ cm.; length 6 cm.

D	H'	$H-H'$	$10^{-3}V$
cm.	cm.	cm.	volts.
1.27	58.08	6.49	20.2
1.27	59.83	6.88	20.4
1.27	60.51	6.95	20.4
1.27	61.04	7.08	20.5
1.02	68.43	14.15	22.0
1.53	60.12	5.70	22.3
1.79	57.85	3.33	20.3
2.04	57.81	3.05	22.1

These values of V for so large variation of D ($H-H'$ increasing about 5 times) are to be regarded as a satisfactory test, the fluctuation of values being again attributable to the electrical machine. In these absolute values, however, the potentials V found were somewhat larger than would follow from the results of an interposed spark-gap with balls about 2 cm. in diameter. The spark would have been equivalent to about 16,000 volts. Sparks, however, here occur too rapidly for measurement.

A number of experiments tried by interposing solid disks between the condenser plates led throughout to inadmissible results. In case of a mica plate lying on the guard ring, the whole cylinder of oil between the metal disk at the top and the mica plate must eventually have reached constant potential, the charge being carried by convection to the top face of the mica. The diver, therefore, clings to the mica plate, which in an insulating medium can not be again discharged. All measurement is thus out of the question. In case of thick glass plates completely filling the condenser space, other

difficulties were encountered from the frequent presence of air bubbles between the plate and the disk of the diver. It was difficult to remove them completely, and all attempt at measurement failed. In general solids take a permanent charge which can not be removed by any means offered by the apparatus. They must therefore be avoided for condenser purposes.

A return to the oil-condenser with a number of minor improvements showed the results recorded in table 14.

TABLE 14.—Constants as in table 13, III. $M=37.89$ grams.

D	H'	$H-H'$	$10^{-3}V$	Spark.	$10^{-3}V$	D	H'	$H-H'$	$10^{-3}V$	Spark.	$10^{-3}V$
cm.	cm.	cm.	volts.	cm.	volts.	cm.	cm.	cm.	volts.	cm.	volts.
1.27	51.66	5.13	19.0	0.54	19.0	2.29	50.83	1.66	19.5
1.27	52.00	4.26	17.2	2.04	51.12	1.90	19.4	0.52	18.0
1.27	51.66	3.14	14.8	1.79	51.35	2.05	17.5
1.53	50.92	2.13	14.9	.47	16.0	1.53	52.00	2.63	17.5
1.79	50.23	1.23	13.2	1.27	53.77	4.35	17.1	.47	16.0
2.04	51.05	2.05	18.8	.57	19.0	1.02	57.20	7.73	17.7
2.29	50.70	1.70	19.876	67.90	18.48	18.9
2.55	50.55	1.45	20.5						

These data appear to be trustworthy throughout and measure the unavoidable fluctuation of the potential of the electrical machine. They are of the same order, moreover, as the spark potentials, remembering that these had to be determined before and after the electrometer potentials. Adequate precautions for the spark work could not be taken. The range of D is large, increasing from 0.8 cm. for the largest admissible forces to 2.5 cm. Below 0.8 cm. pressure would have been needed to sink the diver. In case of table 14 the diver is released suddenly and falls as a whole, giving all necessary accuracy to its H' . Naturally this sudden drop is essential, for the equations used are only true when the disk is flush with the guard ring. A diver descending obliquely or sluggishly would not be trustworthy. The apparatus need not be air-tight and a slight leak assists in the determination of H' . Other similar experiments were made with the same order of values, which need not therefore be recorded here.

Finally, certain experiments were improvised in the endeavor to measure relatively low potentials of the order of 300 volts. Here the apparatus should be quite free from leak, as the change of H under these conditions is of the order of 1 mm. of mercury. Any thermal discrepancy in the partially exhausted air, the presence of small air bubbles clinging to the diver, would otherwise mask the effect to be measured. Finally, as the distance apart of the plates is necessarily small, 1 mm. and less, special precautions must be taken with this magnitude. The results obtained need not be given here, as the work was undertaken merely to show that the apparatus works smoothly even under these limiting conditions.

From equation (7) above,

$$\Delta H = H - H' = \frac{H' + h\rho_w/\rho_m}{8Mg} \frac{V^2 R^2}{(300)^2 D^2}$$

whence it appears that the lightest possible diver, observed at nearly atmospheric pressure, for as large an area of the movable disk and as small a distance apart of the condenser plates as possible, would here be conducive to the best results. An apparatus constructed so that

$$H' = 75 \text{ cm.} \quad R = 15 \text{ cm.} \quad D = 0.05 \text{ cm.} \quad M = 60 \text{ grams}$$

should show $\Delta H = 1$ cm. about for 100 volts, which appears to be the lower limit of measurement. The higher limit, if the disks are made small, M and D large, seems to be indefinite, providing all sharp edges can be obviated. So far as present experiments went the general behavior of the apparatus was quite satisfactory. The drop is rapid and definite, facilitating accurate pressure measurement. The apparatus need not be quite airtight, since $H' - H$ is the variable in terms of which potential is to be found. The large values of D (several centimeters) which seem to be admissible without vitiating the simple form of equation is an additional advantage, so that sparks may in a measure be avoided. A heavier oil than kerosene would perhaps be advisable, though sparks may occur without danger in any case.

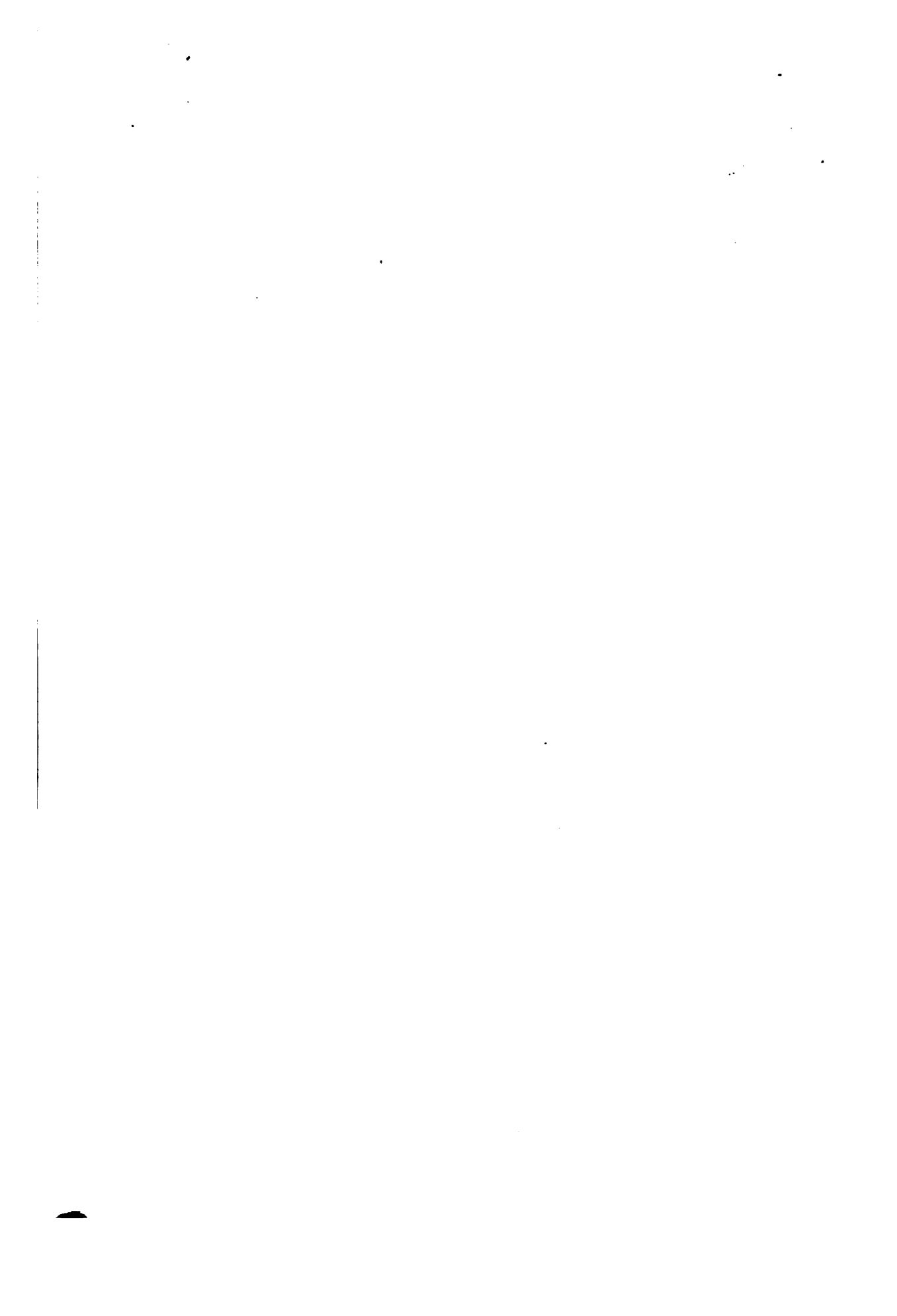

CHAPTER IV.

THE DIFFUSION OF GASES THROUGH SOLUTIONS AND OTHER LIQUIDS.

36. Purpose.—In the earlier investigation (Chapters I and II) certain questions were left outstanding. The first of these refers to the diameter of the column of liquid through which diffusion takes place. It must be decided, if possible, whether variations in the area of the column exceeding its minimum area have as small an effect as was assumed. Again, when a gas other than air is examined, the Cartesian diver must be charged in an artificial atmosphere of the gas in question, so that there may be no access of air. The artificial atmosphere must therefore be constantly renewed. Even the partial exhaustions should be made so far as possible in the absence of air. Again, endeavors are to be made to secure adequately equable temperature conditions, but the facilities of the laboratory for this purpose are meager.

Finally, the effect of the solution of solids and liquids on the rate of diffusion of the gas through water is an interesting question. What is to be determined is the degree to which the physical pores of the pure liquid are stopped up with different quantities and different kinds of solute. Different solvents may also be taken in question.

37. Apparatus.—Hence the apparatus with which the present experiments are to be undertaken must, at least in part, be of the type shown in fig. 4, Chapter II. They were constructed in some variety, but the form shown in the annexed fig. 16 was finally preferred. Here *vd* is the Cartesian diver capable of rising in the tube *cm*, open below, closed above by the stoppered thermometer *t* and kept full of water. Thus the bulb of this thermometer serves additionally as a stop for the diver on flotation. The diver must fit very loosely in the tube, so that there may be a minimum of viscous resistance to its vertical motion. There should be at least 0.5 cm. clear space all around the diver. To prevent it from sinking completely, a vertical sheet of mica, *e*, slightly flexed so as to hold its position in an axial plane by reason of its elasticity, was eventually adopted in preference to wire gauze. The wider and outer tube, *A*, is so chosen that the area *r* of the mouth of the diver may be equal to that of the annular space without, as nearly as possible, throughout. The gas in the space *H* above the free surface *f* of the liquid may be changed and kept at any pressure by aid of the tubes *a* and *b*.

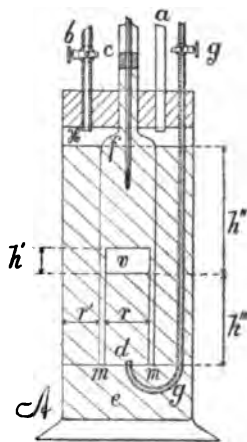

FIG. 16.—Improved Cartesian diver with double tube and influx pipe.

The tube *gg* is of use in charging the diver with gas. For this purpose the apparatus *A* is inverted and then brought back to the erect position in the figure so that the diver may be completely filled with the liquid. The gas in question is then introduced in small bubbles through *gg*, while the gas at *H* is kept about at the pressure (less than 0.1 atmosphere) at which the experiment is to begin. When the diver rises the tube *gg* is closed. It must subsequently be quite filled with the liquid by suction above, so that there may be no accidental leakage of air from *g* to *v*. In fact, the tube *g* may with advantage be straight. Gas may be led into *v* by tipping the apparatus. Otherwise it escapes into *H* without charging the diver.

TABLE 15.

No.	<i>M</i>	ρ_g	Vessel.		Tube.		Float.		
			<i>2r</i>	<i>a</i>	<i>2r</i>	<i>a</i>	<i>2r</i>	<i>a</i>	<i>l</i>
A.....	12.011	2.484	4.40	15.2	3.3	8.5	2.95	6.8	7-8
B.....	37.425	2.470	5.80	26.4	3.8	11.3	5-6
C.....	14.448	2.487	4.60	16.6	2.85	6.4	6-7
E.....	14.897	2.466	4.70	17.3	3.0	7.1	11-12
F.....	23.545	2.466	4.70	17.3	3.0	7.1	11-12
H.....	11.653	2.466	4.65	17.0	3.45	9.3	3.05	7.3	7-9
EE.....	12.472	2.466	4.70	17.3	3.0	7.1	4.5-5.5
FF.....	10.939	2.466	4.70	17.3	3.0	7.1	6-7
K ₂ SO ₄	8.643	2.466	4.70	17.3	3.03	7.2	6-7
BaCl ₂	7.496	2.466	4.70	17.3	3.0	7.1	5-6
A.....	12.011	2.484	4.40	15.2	2.95	6.8	7-8
H.....	11.653	2.466	4.65	17.0	3.05	7.3	7-9

When relative results only are in question, as, for instance, when different strengths of a given solution are compared with water, the simpler apparatus with a single tube is preferable. It is virtually standardized with water at the beginning or end of the experiments. Unfortunately, in the earlier part of the experiments the temperature difficulty was still encountered in the following work, there being no chamber of constant temperature available. Later such a chamber was improvised.

The constants of the floats used in the present chapter are given in table 15.

The divers were usually cut from test tubes and matched with regard to the area of their mouths with the area of the stand glasses, in order to make the area of the float and the annular area outside of it as nearly as possible the same. The tubes should be of relatively heavy glass, so as to insure a low position of the free surface within, permanently in the cylindrical part of the test-tube. Otherwise the free surface is liable to contract into the spherical part at the end, and a correction for this diminution of area is difficult.

38. Equations.—It will be expedient in the present research to compute the coefficient of diffusion by volume, relatively to standard pressure and temperature, and this may always be done even in the case of mixed gases. The flotation experiments thus give

$$v_0 = \frac{273M}{76} \left(\frac{1}{\rho_w} - \frac{1}{\rho_f} \right) \frac{H}{\tau} = C \left(\frac{1}{\rho_w} - \frac{1}{\rho_f} \right) \frac{H}{\tau} \quad (1)$$

where v_0 is the volume of gas in cubic centimeters in the diver, at 273° absolute, and 76 cm. of the barometer. M is the mass of the swimmer, ρ_f its density, ρ_w the density of the liquid, at the absolute temperature τ . H is the pressure in centimeters of mercury at which flotation just takes place at the given fiducial level. If B is the barometric height, h the head (including capillary depression) of the mercury manometer communicating with the gas above the free surface, h' the height of the bubble of gas in the swimmer,

$$H = B + h' \rho_w / \rho_m - h - x - \pi \quad (2)$$

where ρ_m is the density of mercury, π the vapor pressure of water or of a solution at τ° , x the surface depression of the cistern of the manometer. In all the adjustments used

$$H = B + 0.05 - 1.01h - \pi$$

The density ρ_w is easily found for any solution, but it is not always possible to obtain π' the reduced vapor pressure due to solution. Methods will be given for each table. Their effect is usually insignificant.

The above equations for the interdiffusion of two gases (H initially alone within the diver and finite in quantity, A without and unlimited in quantity) are, as above shown, when the volume coefficient κ refers to 0° C. and 76 cm. of mercury,

$$-\frac{2h''' + h''}{a} \dot{v}_0 = p_h(\kappa_h - \kappa_a) + \kappa_a h'' \rho_w g \quad (3)$$

where h'' and h''' are the heads of the liquid shown in fig. 16, a the area of the diffusion column, p_h and p_a the partial pressures of the gases within the diver, κ_h and κ_a their volume diffusion coefficients, and ρ_w the density of the liquid. Throughout the experiments if B is the height of the barometer

$$B - \pi = p_a + p_h - h'' \rho_w g \quad (4)$$

Hence if but a single gas A is present, p_h is zero and

$$-(2h''' + h'') \dot{v}_0 / a = \kappa_a h'' \rho_w g \quad (5)$$

from which κ_a may be computed from observations of v_0 in the lapse of time. Moreover,

$$\kappa \rho_0 = k \quad (6)$$

the coefficient of diffusion referring to mass, which can not therefore be found except in case of a single gas, where ρ_0 is given. One may observe that

$$\dot{v}_0 / a = h'_0 \quad (7)$$

where h'_0 is the height of the cylindrical air bubble within the diver at standard pressure and temperature. The variations of h'_0 in the lapse of time are not, however, measurable with adequate accuracy.

In equation (3) κ_h can not be found even when κ_a is given, unless p_h is also given, which is not generally the case in a phenomenon so complicated. If equation (3) is expressed in terms of p_a

$$-\frac{2h''' + h''}{a} \dot{v}_0 = (B - \pi - p_a + h'' \rho_w g)(\kappa_h - \kappa_a) + \kappa_a h'' \rho_w g \quad (8)$$

Hence, since at the beginning $p_a = 0$,

$$-(2h''' + h'') \dot{v}_0 / a = (B - \pi + h'' \rho_w g) \kappa_h - (B - \pi) \kappa_a \quad (9)$$

so that for given κ_a , κ_h may be found from the slope of the initial tangent of the time graph.

If $p_a = h'' \rho_w g$,

$$-\frac{2h''' + h''}{a} \dot{v}_0 = (B - \pi) \kappa_h - (B - \pi - h'' \rho_w g) \kappa_a \quad (10)$$

so that κ_h can again be found if this stage of diffusion can be recognized, which is not generally the case. When $v_0 = 0$,

$$p_h(\kappa_h - \kappa_a) = \kappa_a h'' \rho_w g \quad (11)$$

which still contains the two unknown quantities, p_h and κ_h , for known κ_a .

If the gases within and without the diver are initially identical, but in multiple as in the case of air, the quantities being limited within and unlimited without,

$$-\frac{2h''' + h''}{a} \dot{v}_0 = \kappa_a (p'_a - p_a) + \kappa_h (p'_h - p_h) \quad (12)$$

Since $B - \pi = p_h + p_a$ and $B - h'' \rho_w g - \pi = p'_h - p'_a$, the equation may be written

$$-\frac{2h''' + h''}{a} \dot{v}_0 = (\kappa_a - \kappa_h) p'_a - (\kappa_a - \kappa_h) p_a + \kappa_h h'' \rho_w g \quad (13)$$

If κ_a and κ_h are not the same, the term involving p'_a is variable and hence \dot{v}_0 is not constant. Theoretically this is an objection against the use of air as a standard gas. In practice, however, \dot{v}_0 is, apart from temperature discrepancies, very nearly constant, *i. e.*, the departure of the time graph from a straight line throughout a sufficiently long interval of observation can not be detected (see transpiration figures, Chapter II). Hence the two diffusion coefficients are nearly enough the same to justify equation (5) in most cases if sufficient time has elapsed to establish the equilibrium conditions. The extreme difficulty of using any other gas and the special errors introduced by the necessity of an artificial atmosphere more than counterbalance the theoretical preference suggested.

39. Diffusion of Air into Air Through Water.—The apparatus used was of the double-tube type of fig. 16 and its dimensions are given at the head of table 16. The float fitted the tube somewhat too snugly, so that observation was very slow, owing to the thin sheet of water between diver

and tube. Inasmuch as the forces are known, it may be worth while to test the method for measuring the viscosity of the liquid. Table 16 and those which follow contain the date, the corresponding value of v_0 , and the other data needed to compute κ by equation (5). M denotes the mass of the float, ρ_f its density, ρ_w the density of the liquid at the temperature given. Diameters of vessels are referred to under $2r$; h' , h'' , h''' are the vertical heights of bubble, the water head for the diver when sunk, and the effective height of the water level within the diver, above its mouth. The head h'' is liable to vary in the lapse of time.

TABLE 16.—Air-air through water. Vessel A (double tube). $M=12.011$; $\rho_f=2.484$; $C=43.14$; float, $2r=2.95$; tube, $2r=3.3$; vessel, $2r=4.4$. $h'=1.8$, $h''=4.7$, $h'''=7.0$.

Date.	Barom-eter.	t	H	v_0	Date.	Barom-eter.	t	H	v_0
		°C.					°C.		
Sept. 17..	76.24	20.7	65.49	5.775	Oct. 12..	76.40	22.6	51.21	4.489
18..	76.06	21.0	65.80	5.796	14..	76.88	22.3	49.97	4.385
19..	75.85	21.0	65.26	5.749	15..	76.08	22.4	49.43	4.336
20..	76.03	21.6	64.86	5.703	16..	76.92	19.7	47.97	4.242
21..	76.90	18.5	63.65	5.650	17..	76.44	20.5	47.27	4.170
23..	76.81	17.0	61.38	5.474	18..	76.38	22.2	47.39	4.159
24..	77.00	17.0	61.08	5.447	19..	75.97	22.0	46.77	4.107
25..	76.72	17.3	60.60	5.400	21..	77.29	21.3	45.36	3.992
26..	76.54	17.4	60.34	5.375	22..	77.08	21.2	44.83	3.946
27..	76.31	17.4	59.70	5.318	23..	76.05	22.3	44.69	3.921
28..	77.04	19.0	59.50	5.274	24..	75.29	23.3	44.83	3.922
30..	76.90	17.2	58.52	5.216	25..	75.68	20.2	43.91	3.877
Oct. 1..	76.03	17.7	57.41	5.109	26..	75.66	20.0	43.36	3.831
2..	76.58	18.2	57.05	5.069	28..	76.20	20.0	42.39	3.745
3..	76.33	20.2	56.74	5.010	29..	76.58	20.0	41.94	3.706
4..	76.10	23.0	58.20	5.095	30..	75.80	19.8	41.42	3.662
5..	76.69	20.4	56.68	5.002	Nov. 1..	75.91	19.4	40.61	3.595
7..	75.68	19.0	54.30	4.813	2..	75.62	19.4	40.42	3.578
8..	76.34	19.8	53.43	4.724	4..	77.33	18.7	39.22	3.479
9..	76.78	21.2	52.87	4.654	5..	76.89	18.5	39.10	3.471
10..	76.27	22.7	52.64	4.611	6..	76.82	18.2	38.43	3.414
11..	76.72	21.6	51.62	4.539					

The present case of diffusion of air through water in the double-tube apparatus is rather a disappointment in comparison with the long series of results obtained above with the single-tube apparatus, inasmuch as the diffusion after all allowances are made for differences of constants takes place much faster than in the original experiment. Fig. 17, moreover, apart from fluctuations due to variation of solution with temperature, shows two different rates, the slower in September preceding a in figure and the faster in October, following a , whereas no variation whatever had taken place in the apparatus to our knowledge. It is very difficult to interpret this, for it is hardly conceivable that any appreciable change of equivalent importance should have occurred in the air of the room.

The excessive rate of diffusion here observed occurs for the case where the diffusion column is narrowed throughout, to a nearly constant diameter as compared with the large diffusion column above the swimmer which

obtained in the earlier experiments. One should have anticipated a slower rate of diffusion if any change of rate were to be found. The reverse is the case.

The only explanation of the large rate encountered may possibly be found in the fact that the partition on which the diver descended or rested during quiescence was a sheet of clean copper. It is not improbable that the oxidation of this sheet in the lapse of time increases the effective gradient as the metal becomes a sink for oxygen. In other words, the normal diffusion gradient is enhanced by the chemical effect introduced. If this proves to be the case, the experiment presents a rather sensitive test for such action, as the diffusion coefficient has been increased nearly three times.

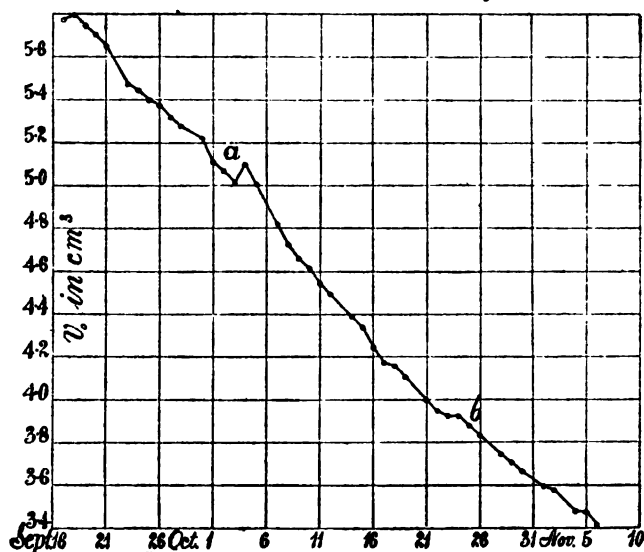

FIG. 17.—Chart showing loss of standard volumes of gas in diver in lapse of days. Diffusion of air through water.

The diffusion coefficients by volume κ computed from table 16 for the two rates specified are

$$\dot{v}_0 = 0.0445 \text{ c.c./day, or } \kappa \times 10^{10} = 2.86 \quad \dot{v}_0 = 0.0539 \text{ c.c./day } \kappa \times 10^{10} = 3.59$$

showing the mean value $10^{10}\kappa = 3.22$ at 0°C. and 76 cm. of mercury. In view of these discrepant results it is necessary to consider the case of air under varying conditions, as will now be done for the present apparatus. In §41, moreover, swimmers of different dimensions will be substituted.

I may note in conclusion that a gradually rising temperature would decrease the apparent diffusion owing to the gradual rejection of gas from the water within the diver, whereas a gradually falling temperature would have a reverse effect. It would be very difficult to discriminate, in such a case, between the true diffusion and the solution discrepancy.

The double-tube apparatus *A* was eventually removed to a vault of more constant temperature and taken out for observation only, leaving the copper partition in place. These new results are included in table 16, after

October 24, and fig. 17, following *b*, at the end of each. The new diffusion constants were somewhat smaller than the above, but they are still much higher than the normal values, *i. e.*, the new data are equivalent to

$$v_0 = 0.0383 \text{ c.c./day; whence } 10^{10} \kappa = 2.56$$

To interpret this result, it will first be necessary to remove the copper partition, which has been supposed to be an absorbent for oxygen, and to replace it by a partition of mica. This will be done in the next paragraph.

Including the last results the mean constants for the 50 days of observation would be

$$v_0 = 0.0505 \text{ c.c./day} \quad 10^{10} \kappa = 3.38$$

retaining the abnormally high value.

40. The Same, Continued.—The apparatus was now taken apart, the copper partition removed and replaced by one of mica of the same height. It was then charged with fresh water, etc., and placed in the vault in question. The record of observations is given in table 17 and fig. 18.

TABLE 17.—Air-air through water. Vessel *A* (double tube). Copper partition replaced by mica. Constants as in table 16.

Date.	Barometer.	<i>t</i>	<i>H</i>	<i>v</i> ₀	Date.	Barometer.	<i>t</i>	<i>H</i>	<i>v</i> ₀
		°					°		
Nov. 9..	75.55	18.9	67.63	5.996	Dec. 3..	76.45	16.5	58.58	5.233
11..	76.33	18.9	65.83	5.837	4..	76.30	16.7	58.52	5.224
12..	75.85	18.7	65.22	5.786	5..	77.06	17.0	58.51	5.219
13..	76.17	19.0	64.59	5.725	6..	75.75	17.4	58.68	5.227
14..	75.69	19.0	64.22	5.692	7..	76.14	17.8	58.83	5.234
15..	75.72	18.7	63.82	5.661	9..	76.28	17.8	59.06	5.254
16..	76.52	18.5	63.48	5.635	10..	76.33	17.8	58.93	5.243
18..	76.26	18.0	62.49	5.556	11..	75.92	17.6	59.05	5.253
19..	76.29	17.7	62.10	5.527	12..	76.16	17.7	58.85	5.237
20..	75.97	17.5	61.70	5.495	13..	77.10	17.3	58.67	5.228
21..	76.31	17.2	61.39	5.472	14..	76.74	17.0	58.45	5.214
22..	75.94	17.4	61.18	5.450	16..	75.40	17.3	58.24	5.189
23..	76.08	17.5	61.09	5.441	17..	76.45	17.4	58.26	5.189
25..	74.91	17.3	60.79	5.417	18..	76.40	17.5	57.89	5.156
26..	76.20	17.3	60.60	5.400	19..	74.34	17.6	58.17	5.179
27..	76.38	17.1	60.44	5.389	20..	75.88	17.4	57.93	5.160
29..	76.95	16.6	59.79	5.340	21..	76.57	17.7	57.80	5.144
30..	76.79	16.6	59.38	5.303	23..	76.75	17.4	57.30	5.104
Dec. 2..	76.60	16.6	58.62	5.235					

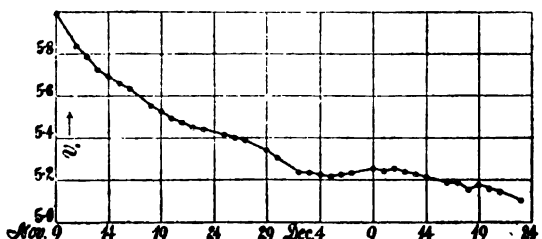

FIG. 18.—Chart showing loss of standard volumes of gas in diver in lapse of days. Diffusion of air through water.

It will be seen that the new march of volumes in the lapse of time is essentially curvilinear throughout the whole interval of examination of 37 days. Only at the end, abruptly, a nearly constant rate appears which is abnormally low. The initial constants are roughly

$$\dot{v}_0 = 0.0225 \text{ c.c./day, or } 10^{10}k = 1.43$$

and the final constants

$$\dot{v}_0 = 0.0072 \text{ c.c./day, or } 10^{10}k = 0.46$$

Thus the mica support has not changed the erratic behavior in the flotation in this vessel, in which the constants have fallen in about 90 days from $10^{10}k = 3.4$, an enormously high value, to $10^{10}k = 0.46$, an abnormally low value, as compared with the usual result of about $10^{10}k = 0.9$. All attempt to interpret this exceptional record has remained futile, but it induced us to discard the double-tube apparatus in most of the experiments below, as being not only much more difficult to manipulate, but (for some occult reason) liable to be untrustworthy in its indications, even after long lapses of time within which equilibrium conditions would certainly have appeared.

41. Diffusion of Air into Air Through Water; Further Experiments.—

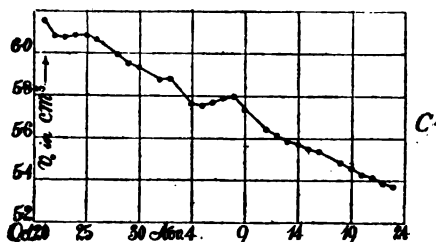
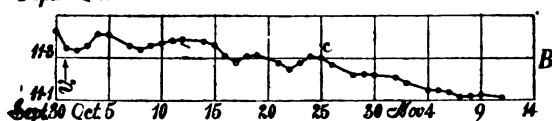
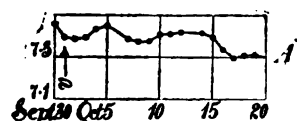

The peculiar behavior of air in the diffusions of §39 made it necessary to install a series of further experiments in which the dimen-

sions of the swimmer were suitably varied. The double-tube apparatus *H*, after the work for which it was destined had been

completed, was also adjusted for air diffusion. In addition to this, there are results for the diffusion of air through water to be made in connection with each of the vessels in which air is to diffuse through solutions, in order that suitable standards may in every case be available.

FIG. 19, A, B, C.—Chart showing loss of standard volumes of gas in diver in lapse of days. Diffusion of air through water.

In tables 18 and 19 two similar divers were introduced into a

single-tube apparatus. They were both made exceptionally long, with a small head h'' and large diffusion column $h'' + 2h'''$, the swimmers being 11 to 12 cm. in length. The effect of this would naturally be to increase the solution discrepancy. One diver was somewhat heavier than the other, the masses being about 15 and 23.5 grams, respectively. Finding that the diffusion progressed with exceptional slowness but quite *identically* (see figs. 19 A and B) in character in the two vessels, the light diver was now cut down to

a length of but 4.5 to 5.5 cm. and the experiment continued under these conditions. The records are given in tables 18, 19, 20, and figs. 19 A, B, C, the long swimmers showing astonishingly slow diffusion. Both were moved to the vault of constant temperature on October 25. (Cf. *c* in fig. 19B).

TABLE 18.—Air-air through water. Vessel *E* (single tube). $M=14.8968$ grams; $C=53.51$; $\rho_0=2.466$; float, $2r=3.00$ cm.; vessel, $2r=4.7$ cm.

Date.	Barom-eter.	<i>t</i>	<i>H</i>	<i>v</i> ₀	Date.	Barom-eter.	<i>t</i>	<i>H</i>	<i>v</i> ₀
		°					°		
Sept. 30..	76.90	17.4	67.85	7.459	Oct. 10..	76.27	22.8	68.51	7.408
Oct. 1..	76.03	18.0	67.36	7.391	11..	76.72	21.7	68.31	7.410
2..	76.58	18.2	67.35	7.385	12..	76.40	22.7	68.61	7.420
3..	76.33	20.4	67.86	7.391	14..	76.88	22.5	68.50	7.413
4..	76.10	22.8	68.74	7.433	15..	76.08	22.4	68.33	7.397
5..	76.69	20.4	68.39	7.449	16..	76.92	19.7	67.23	7.338
7..	75.68	19.0	67.53	7.387	17..	76.44	20.5	67.03	7.299
8..	76.34	19.6	67.51	7.371	18..	76.38	22.2	67.49	7.310
9..	76.78	21.2	67.89	7.376	19..	75.97	22.1	67.49	7.312

TABLE 19.—Air-air through water. Vessel *F* (single tube). $M=23.5450$ grams; $C=84.58$; $\rho_0=2.466$; float, $2r=3.00$ cm.; vessel, $2r=4.7$ cm.

Date.	Barom-eter.	<i>t</i>	<i>H</i>	<i>v</i> ₀	Date.	Barom-eter.	<i>t</i>	<i>H</i>	<i>v</i> ₀
		°					°		
Sept. 30..	76.90	17.4	65.77	11.428	Oct. 21..	77.29	21.2	65.64	11.271
Oct. 1..	76.03	18.0	65.40	11.342	22..	77.08	21.2	65.47	11.242
2..	76.58	18.5	65.45	11.333	23..	76.05	22.3	65.86	11.273
3..	76.33	20.4	65.97	11.357	24..	75.29	23.5	66.29	11.304
4..	76.10	22.8	66.77	11.410	25..	75.68	20.3	65.61	11.299
5..	76.69	20.4	66.26	11.407	26..	75.66	20.2	65.41	11.266
7..	75.68	19.0	65.67	11.354	28..	76.20	20.2	65.13	11.218
8..	76.34	19.6	65.70	11.338	29..	76.58	20.0	65.09	11.219
9..	76.78	21.2	66.12	11.353	30..	75.80	19.9	65.06	11.217
10..	76.32	22.8	66.52	11.368	Nov. 1..	75.91	19.5	64.91	11.205
11..	76.72	21.7	66.37	11.379	2..	75.62	19.5	64.76	11.179
12..	76.40	22.7	66.60	11.384	4..	77.33	18.9	64.45	11.147
14..	76.88	22.5	66.51	11.376	5..	76.89	18.5	64.36	11.144
15..	76.08	22.4	66.39	11.359	6..	76.82	18.3	64.27	11.136
16..	76.92	19.7	65.54	11.306	7..	76.02	18.3	64.16	11.117
17..	76.44	20.5	65.53	11.277	8..	75.07	18.7	64.26	11.119
18..	76.38	22.2	66.04	11.305	9..	75.55	18.9	64.32	11.124
19..	75.97	22.1	66.04	11.309	11..	76.33	18.9	64.25	11.112

The identity of the two curves, figs. 19 A and B, in their indirect fluctuation with temperature is noteworthy, showing that the relative results obtained with a given apparatus are quite trustworthy. The new feature which the curves bring out, however, is unexpected. In other words, the rate of diffusion, which was incidentally found to be relatively large in table 16, is here relatively small, only about one-tenth of the former value. If the mean slope of the curve, fig. 19 A, be taken, the data for the diffusion constants are

$$\dot{v}_0 = 0.0042 \text{ c.c./day or } 10^{10} \kappa = 0.374$$

where the curve of fig. 19B for the same interval of time would have given an identical result. It was therefore to be feared, in so far as these results

are inadmissible, that diffusion decreases with the length of column at a retarded rate; or that the normal volume of gas diffusing per second through a column, *cat. par.*, is not directly dependent upon the pressure gradient, but decreases more rapidly than the gradient. For long, slender swimmers, $l=11$ to 12 cm., κ is so much reduced as to suggest that for greater lengths of column it would practically vanish. Such a behavior was quite puzzling. The only method of interpreting it seemed to consist in continuing the observations in table 20, while the diver in table 19 was cut down to half its length for correlative observation.

The apparatus *E*, after the long swimmer had been cut down to the small length, showed the results recorded in table 20 and fig. 19c.

TABLE 20.—Air-air through water. Vessel *E*. Small swimmer. $M=12.4716$ grams; $\rho_0=2.466$; $C=44.80$; float, $2r=3.00$ cm.; vessel, $2r=4.7$ cm.

Date.	Barometer.	t	H	v_0	Date.	Barometer.	t	H	v_0
		°					°		
Oct. 21..	77.29	21.2	65.49	5.956	Nov. 8..	75.07	23.5	61.94	5.595
22..	77.08	21.2	64.65	5.880	9..	75.55	18.7	60.35	5.532
23..	76.05	22.3	64.79	5.874	11..	76.33	18.7	59.37	5.442
24..	75.29	23.5	65.13	5.883	12..	75.85	18.7	59.04	5.411
25..	75.68	23.4	65.10	5.882	13..	76.17	18.7	58.74	5.384
26..	75.66	22.0	64.65	5.866	14..	75.69	18.7	58.61	5.372
28..	76.20	21.0	63.66	5.794	15..	75.72	18.7	58.36	5.349
29..	76.58	19.9	62.97	5.751	16..	76.52	18.5	58.20	5.338
30..	75.80	21.2	63.05	5.735	18..	76.26	18.0	57.52	5.284
Nov. 1..	75.91	19.5	62.05	5.673	19..	76.29	17.7	57.20	5.260
2..	75.62	20.0	62.20	5.679	20..	75.97	17.5	56.84	5.230
4..	77.33	17.6	60.44	5.560	21..	76.31	17.2	56.61	5.214
5..	76.89	20.2	60.84	5.551	22..	75.94	17.4	56.37	5.188
6..	76.82	21.8	61.32	5.568	23..	76.08	17.4	56.18	5.171
7..	76.02	23.6	61.88	5.587					

A line drawn through the observations as a whole is equivalent to the following rate:

$$\dot{v}_0 = 0.0232 \text{ c.c./day or } 10^{10}\kappa = 0.64$$

This, though small, is a closer approach to the normal value for air found in Chapter II. The result, however, might nevertheless give credence to the occurrence of a length effect, since it may imply that diffusion varies with the length of diver and column. This improbable and disconcerting eventuality is dispelled by the final data of table 19 for the long diver after the time interval of observation had been adequately increased. It follows, therefore, that these long divers merely accentuate the discrepancy due to the thermal changes of solution; for the results obtained with the long swimmer are (fig. 19B):

$$\dot{v}_0 = 0.0082 \text{ c.c./day and } 10^{10}\kappa = 0.78$$

which agree admirably with the results of Chapter II. (See table 21.) The length effect is thus, fortunately, illusory.

As a whole, these experiments show the absolute necessity of long intervals of observation. Whether it be a gradual decline in temperature or solutional effects, or whether fresh solutions or even water require a long

TABLE 21.

Chapter.	Vessel.	10^4k .	Remarks.
II.....	0.83	Single tube.
IV.....	H	.90	Double tube.
	E	.37	Long diver. Short interval.
	EE	.64	Diver shortened.
	F	.79	Long diver. Long interval.

time-interval to reach rigorously normal conditions of equilibrium, the result is patent that the true diffusion rates do not appear until the time-interval has been prolonged sometimes as much as five or six weeks. Even

TABLE 22.—Air-air through water. Vessel *H* (double tube). Constants as in table 23.

Date.	Barometer.	<i>t</i>	<i>H</i>	v_0	Date.	Barometer.	<i>t</i>	<i>H</i>	v_0
		°					°		
Oct. 26..	75.66	22.7	66.19	5.599	Nov. 14..	75.69	19.5	61.00	5.211
28..	76.20	21.8	64.88	5.504	15..	75.72	19.5	60.79	5.193
29..	76.58	20.6	64.15	5.462	16..	76.52	19.1	60.57	5.181
30..	75.80	21.9	64.17	5.442	18..	76.26	18.6	59.81	5.123
Nov. 1..	75.91	20.0	63.15	5.386	19..	76.29	18.3	59.42	5.095
2..	75.62	20.7	63.48	5.403	20..	75.97	18.1	59.13	5.073
4..	77.33	18.3	61.78	5.298	21..	76.31	17.9	58.98	5.064
5..	76.89	20.8	62.41	5.311	22..	75.94	18.0	58.79	5.046
6..	76.82	22.4	62.94	5.329	23..	76.08	18.1	58.59	5.027
7..	76.02	24.2	63.78	5.370	25..	74.91	18.0	58.31	5.005
8..	75.07	24.0	64.12	5.403	26..	76.20	18.0	58.11	4.987
9..	75.55	19.3	62.59	5.351	27..	76.38	17.8	57.72	4.957
11..	76.33	19.5	61.50	5.254	29..	76.95	17.1	56.80	4.888
12..	75.85	19.5	61.15	5.224	30..	76.79	17.5	56.26	4.837
13..	76.17	19.5	61.03	5.214					

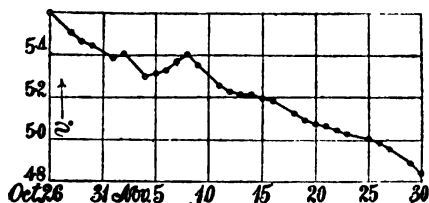

FIG. 20.—Chart showing loss of standard volumes of gas in diver in lapse of days. Diffusion of air through water.

if the curve is smooth, it is always hazardous to assume that the true diffusion rate has been exhibited within a month.

The double-tube apparatus *H* charged with fresh water and air showed the diffusions contained in table 22 and fig. 20.

The rate of diffusion appears as

$$\dot{v}_0 = 0.0185 \text{ c.c./day or } 10^{10}k = 0.90$$

a value which again approaches the normal result in Chapter II, and affords strong credence that the much more troublesome double-tube apparatus is unnecessary in practice.

It is interesting to compare figs. 19 c and 20, which, though obtained with totally different apparatus, show identical thermal discrepancies.

The new results obtained with apparatus *A* have already been discussed. Table 21 is a brief summary of the values for the diffusion of air through water as obtained from totally different apparatus and charges. The untrustworthy results (vessel *A*) are omitted.

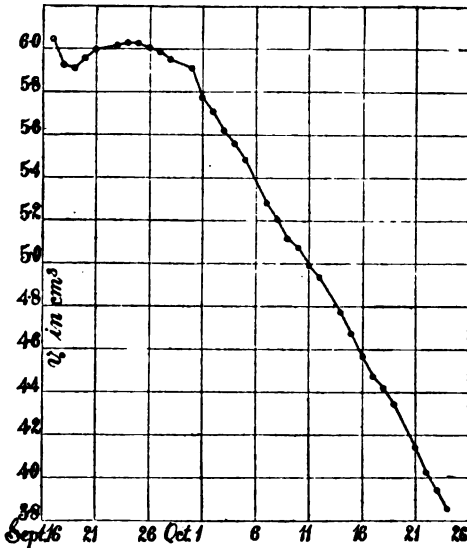

FIG. 21.—Chart showing loss of standard volumes of gas in diver in lapse of days. Diffusion of hydrogen through water.

42. Diffusion of Hydrogen into Hydrogen Through Water.—The apparatus (double tube, fig. 16) and arrangements of results in table 23 are the same as in the preceding case of air. In the present instance, however, an artificial atmosphere of hydrogen had to be supplied. This was obtained from a large gasometer, a slow current of gas from the same passing over the surface of the liquid day and night. The gas as introduced into the diver through the lateral tube in fig. 16 was necessarily taken from the same gasometer, so that the gases within and without the diver might be initially identical.

The case of diffusion of hydrogen through water, in the double-tube apparatus, presents at the outset the usual meandering irregularity, here due to the fact that the measurements were at first made in a temporary medium of air. It was supposed, in view of the brief time of exposure, that no serious discrepancy would be introduced; but the reverse is the case. Consequently, for the remainder of the work, beginning about October 1, the observations were made in the almost entire absence of air, the artificial atmosphere of hydrogen being kept in place during and after the partial exhaustion incident to measurement. The results are now regular, showing the inevitable variations of the temperature of the room which from the low solubility of hydrogen are insignificant in comparison with air.

The diffusion coefficients of hydrogen, computed from table 23, are

$$\dot{v}_0 = 0.080 \text{ c.c./day or } 10^{10}\kappa = 3.4$$

They are again larger than found in Chapter II; but the differences are such as might be ascribed to differences of composition, seeing how extremely sensitive the method is to slight impurities in the diffusing gas, which can not be kept rigorously pure. There remains the inherent temperature effect, the influence of which on diffusion proper (apart from solution) has yet to be investigated, both for hydrogen and for air. It is noteworthy, however, that the κ of the present observations, *i. e.*, in a diffusion column

TABLE 23.—Hydrogen-hydrogen through water. Vessel *H* (double tube). $M=11.653$ grams; $\rho_0=2.466$; $C=41.85$; float, $2r=3.05$ cm.; tube, $2r=3.4$ cm.; vessel, $2r=4.6$ cm.

Date.	Barom-eter.	<i>t</i>	<i>H</i>	v_0	Date.	Barom-eter.	<i>t</i>	<i>H</i>	v_0
		°					°		
Sept. 17..	76.24	22.5	71.37	6.041	Oct. 7..	75.68	20.0	61.92	5.281
18..	76.06	21.5	69.75	5.922	8..	76.34	20.2	61.10	5.208
19..	75.85	22.0	69.71	5.910	9..	76.78	21.8	60.30	5.115
20..	76.03	23.0	70.51	5.959	10..	76.27	23.0	60.04	5.074
21..	76.90	19.6	70.20	5.995	11..	76.72	22.0	58.88	4.992
23..	76.81	18.2	70.16	6.017	12..	76.40	22.9	58.41	4.938
24..	77.00	18.2	70.30	6.029	14..	76.88	22.7	56.42	4.772
25..	76.72	18.2	70.22	6.023	15..	76.08	22.7	55.23	4.672
26..	76.54	18.4	70.07	6.006	16..	76.92	20.0	53.57	4.569
27..	76.31	18.4	69.84	5.986	17..	76.44	20.8	52.59	4.475
28..	77.04	19.9	69.73	5.950	18..	76.38	22.4	52.20	4.420
30..	76.90	18.0	68.86	5.910	19..	75.97	22.1	51.23	4.342
Oct. 1..	76.03	18.4	67.34	5.772	21..	77.29	21.4	48.79	4.144
2..	76.58	19.0	66.67	5.704	22..	77.08	21.3	47.42	4.029
3..	76.33	20.7	66.01	5.618	23..	76.05	22.4	46.54	3.941
4..	76.10	23.0	65.78	5.560	24..	75.29	23.5	45.71	3.857
5..	76.69	21.0	64.47	5.482					

nearly constant in diameter, comes out larger than it was found above for a widening column. In any case the true diffusion coefficient for rigorously pure hydrogen is yet to be found, inasmuch as the small admixtures in question have so marked an effect. Thus the gas in the gasometer which is used for the artificial atmosphere, even if generated quite pure, soon becomes appreciably less so, since it must suffer contamination with the air diffusing through the water of the gasometer over which the hydrogen is stored. Since such large quantities are needed, mercury storage is nearly out of the question. Hence the work with hydrogen was abandoned temporarily at this stage, the coefficient last found, $10^{10}\kappa=3.4$ for the volume diffusion at 0°C . and normal pressure, being preferable.

43. Diffusion of Air into Air Through KCl Solution.—The solution of KCl contained, after mixing, about 120 grams in 600 c.c. of solution. Its density was found to be 1.1133 at 24.5° . From this a table of densities ρ_w was computed between 16° and 25° , assuming the expansion to be the

same as that of water. The solution may therefore be regarded as holding 20.8 grams of KCl in 100 grams of water, or 17.2 grams of salt in 100 grams of solution. To obtain the vapor pressure π' of the moist air above the solution, it was at first assumed that the reduction of vapor pressure at 18° was *relatively* the same as at 0° C. for a given strength of solution. Furthermore, that the case of KCl would be practically identical with the case of brine. Afterwards (using Landolt and Boernstein's tables) it was found that such an assumption is inadmissible and that the equation should be

TABLE 24.—Air-air through KCl solution (20.8 grams in 100 grams water). Vessel B (single tube). $M=37.425$ grams; $C=134.43$; $\rho_f=2.470$; float, $2r=3.8$ cm.; vessel, $2r=5.8$ cm. $\rho_w=1.1133$ at 24.5°.

Date.	Barom-eter.	t	H	v_0	Date.	Barom-eter.	t	H	v_0
		°					°		
Sept. 18..	76.06	19.8	67.32	15.223	Oct. 7..	75.68	19.2	64.78	14.675
19..	75.85	21.2	66.54	14.981	8..	76.34	19.6	64.69	14.638
20..	76.03	22.0	66.26	14.878	9..	76.78	21.5	65.04	14.631
21..	76.90	18.8	65.33	14.820	10..	76.27	23.0	65.37	14.637
23..	76.81	17.0	64.67	14.752	11..	76.72	21.9	65.17	14.640
24..	77.00	17.4	64.62	14.718	12..	76.40	22.9	65.33	14.633
25..	76.72	17.8	64.74	14.731	14..	76.88	22.6	65.23	14.622
26..	76.54	17.8	64.70	14.722	15..	76.08	22.5	65.11	14.600
27..	76.31	17.8	64.62	14.703	16..	76.92	19.8	64.43	14.570
28..	77.04	19.2	64.95	14.713	17..	76.44	20.4	64.49	14.556
30..	76.90	17.4	64.94	14.793	18..	76.38	21.6	64.74	14.559
Oct. 1..	76.03	18.0	64.53	14.674	19..	75.97	22.0	64.84	14.561
2..	76.58	18.2	64.65	14.690	21..	77.29	21.2	64.38	14.494
3..	76.33	20.2	65.02	14.684	22..	77.08	21.1	64.36	14.495
4..	76.10	22.7	65.56	14.691	23..	76.05	22.4	64.59	14.486
5..	76.69	20.8	65.20	14.699					

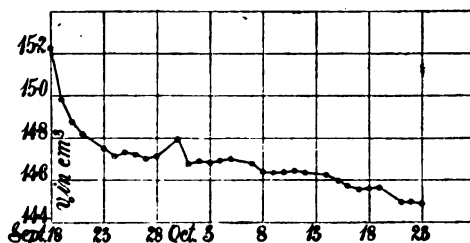

FIG. 22.—Chart showing loss of standard volumes of gas in diver in lapse of days. Diffusion of air through KCl solution.

$\pi' = \pi(1 - 0.086)$ for KCl. Hence these data for KCl in the table must be corrected before the diffusion coefficients are computed, as follows: The error of π' being $\delta\pi' = 0.029\pi$, its effect on v_0 will be

$$-\frac{\partial v_0}{\partial H} \delta\pi' = -v_0 \frac{\delta\pi'}{H}$$

This correction is to be supplied in the summary. For brine, by graphic interpolation, using either Dieterici's or Smits's observations, the correction is $\pi' = \pi(1 - 0.115)$, and this is provisionally used in table 24 and fig. 22.

The diffusion of air through strong KCl shows at the outset a peculiarly rapid march. This is probably due to the fact that, to remove air bubbles, the water was placed under a relatively high partial vacuum. The rapid diffusion observed is in correspondence with the restoration of a normal amount of air to the water. Thereafter the march of results is fairly regular, apart from the invariable temperature fluctuation. From a mean line drawn through the observations, the coefficient of diffusion may be found as follows:

$$\dot{v}_0 = 0.0072 \text{ c.c./day, or } 10^{10}\kappa = 0.137$$

These data are to be converted, as stated above, by deducting $\delta\pi'/H$ of their value where $H=65$ and $\pi=1.5$, so that $\delta\pi'/H=0.044/65$ which is not appreciable in its bearing on κ .

The coefficient is thus smaller than the lowest result for air and water, or quite small as compared with the normal datum for an air-and-water system. It follows, therefore, that the intermolecular pores of water are quite effectively stopped up by the presence of KCl molecules between them. Diffusion proceeds much more slowly.

It would be an interesting inquiry to find how different gases behave in relation to this stoppage; but the work is not yet advanced enough to warrant speculation on such questions. It is obvious, however, that from extended series of results like the following, definite conclusions as to the effect of density of solution and chemical constitution, etc., on the structure of the molecular pores must eventually be reached.

44. The Same, Continued.—The solution was now diluted with water to about double the above volume, showing the density of $\rho_w = 1.063$ at 23° . This is equivalent to 9.9 grams of KCl in 100 grams of solution, or to 11.0 grams of salt in 100 grams of water. The vapor pressures are now larger, $\pi' = \pi(1 - 0.063)$ being the value inserted and holding as above stated for brine. The reduction to KCl requires $\pi' = \pi(1 - 0.044)$, so that the correction $\delta\pi' = 0.019\pi$ and in $-(\partial v_0/\partial H)\delta\pi' = -(v_0/H)\delta\pi'$, the factor $\delta\pi'/H = 0.029/65$ is too small to make its effect appreciable. In other respects the experiments were made as above. Table 25 and fig. 23 show the results.

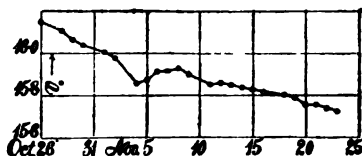

FIG. 23.—Chart showing loss of standard volumes of gas in diver in lapse of days. Diffusion of air through KCl solution.

If a mean line is drawn through the data as a whole, the results are

$$\dot{v}_0 = 0.0115 \text{ c.c./day or } 10^{10}\kappa = 0.209$$

showing some increase of κ as compared with the concentrated solution ($10^{10}\kappa = 0.137$); but in relation to pure water by no means as large an incre-

ment as would be expected for a dilution to nearly half the original strength. The stoppage effect of a content of but 10 per cent of salt is still pronounced.

TABLE 25.—Air-air through KCl solution (11 grams in 100 grams water). Vessel B (single tube). Constants as in table 24. $\rho_w = 1.063$ at 23° .

Date.	Barometer.	t	H	v_0	Date.	Barometer.	t	H	v_0
		°					°		
Oct. 26..	75.66	22.2	66.20	16.150	Nov. 11..	76.33	19.1	64.36	15.850
28..	76.20	21.1	65.80	16.106	12..	75.85	19.0	64.37	15.858
29..	76.58	20.0	65.40	16.063	13..	76.17	19.0	64.33	15.848
30..	75.80	21.5	65.60	16.039	14..	75.69	19.0	64.27	15.833
Nov. 1..	75.91	19.6	65.08	16.003	15..	75.72	19.0	64.24	15.826
2..	75.62	20.3	65.12	15.978	16..	76.52	18.9	64.17	15.814
4..	77.33	17.8	64.12	15.859	18..	76.26	18.3	64.00	15.801
5..	76.89	20.4	64.72	15.873	19..	76.29	18.0	63.88	15.788
6..	76.82	22.1	65.20	15.911	20..	75.97	17.8	63.70	15.755
7..	76.02	24.0	65.52	15.914	21..	76.31	17.6	63.68	15.757
8..	75.07	24.0	65.64	15.928	22..	75.94	17.8	63.64	15.740
9..	75.55	19.1	64.56	15.899	23..	76.08	17.9	63.59	15.722

45. **The Same, Continued.**—The solution was now again diluted to about one-half strength, thus showing about one-fourth the original concentration, and the daily run of results taken as in table 26 and fig. 24, with the same vessel and float as before. The density of solution was $\rho_w = 1.0295$ at 21° , implying 4.2 grams in 100 grams of solution, or 4.4 grams

TABLE 26.—Air-air through KCl (4.4 grams in 100 grams water). Vessel B (single tube). Constants as in table 24. $\rho_w = 1.0295$ at 21° .

Date.	Barometer.	t	H	v_0	Date.	Barometer.	t	H	v_0
		°					°		
Nov. 25..	74.91	17.7	64.74	16.939	Dec. 9..	76.28	18.1	63.49	16.593
26..	76.20	17.6	64.55	16.895	10..	76.33	18.1	63.33	16.551
27..	76.38	17.5	64.35	16.849	11..	75.92	17.9	63.22	16.533
29..	76.95	17.0	64.03	16.791	12..	76.16	17.9	63.10	16.502
30..	76.79	17.0	63.67	16.697	13..	77.10	17.7	62.92	16.463
Dec. 2..	76.60	16.9	63.32	16.611	14..	76.74	17.4	62.83	16.457
3..	76.45	16.9	63.37	16.624	16..	75.40	17.4	62.64	16.407
4..	76.30	17.1	63.41	16.623	17..	76.45	17.5	62.60	16.390
5..	77.06	17.3	63.33	16.593	18..	76.40	17.8	62.46	16.340
6..	75.75	17.7	63.47	16.607	19..	74.34	17.8	62.34	16.309
7..	76.14	18.1	63.47	16.587	20..	75.88	17.9	62.21	16.269

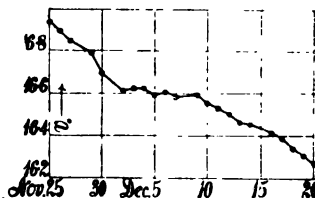

FIG. 24.—Chart showing loss of standard volumes of gas in diver in lapse of days. Diffusion of air through KCl solution.

in 100 grams of water. The vapor pressure was put $\pi' = \pi(1 - 0.017)$. The chart shows the results, which are unfortunately irregular for some unexplained reason, there being in the usual way a very slow adjustment to the equilibrium conditions, after which the gas diffuses at a fairly regular rate.

The diffusion constants are (vessel *B*),

$$\dot{v}_0 = 0.0222 \text{ c.c./day or } 10^{10}k = 0.423$$

a reasonable advance on the former rates. The three curves for KCl solutions show that not until after the lapse of two weeks do definite rates appear. These essentially final rates are the ones taken. In each case there seems to be an adjustment of the gas (O_2, N_2), which actually diffuses, to the solution.

46. The Same, Continued.—On further dilution with about an equal volume of water the density of the solution was $\rho = 1.0170$ at 21° , corresponding to 2.65 grams in 100 grams of solution, or 2.7 grams in 100 grams of water. Thus the vapor pressure became $\pi' = \pi(1 - 0.010)$.

The progress of the diffusion is given in table 27 and fig. 25. The latter shows marked irregularity at the beginning (as usual), but the curve becomes fairly smooth when daily observations are replaced by weekly observations. Clearly, therefore, the daily churning up of the solution during observation, usually at a relatively high temperature, is unfavorable to a steady progress of results. The locus, however, is not quite straight, for reasons which can not be inferred, as temperature was fairly constant.

TABLE 27.—Air into air through KCl solution (2.7 grams in 100 grams water). Constants as in table 24. Vessel *B*. $\rho_w = 1.0170$ at 21° .

Date.	Barometer.	<i>t</i>	<i>H</i>	<i>v</i> ₀	Date.	Barometer.	<i>t</i>	<i>H</i>	<i>v</i> ₀
		°					°		
Dec. 21..	76.57	18.0	65.50	17.484	Jan. 1..	76.01	18.2	64.41	17.181
23..	76.75	17.8	65.00	17.362	2..	76.87	18.3	64.35	17.162
24..	75.70	17.7	64.87	17.330	3..	73.98	18.4	64.49	17.193
26..	77.10	17.3	64.47	17.247	10..	77.35	17.9	63.85	17.050
28..	75.50	17.6	64.49	17.234	17..	76.54	17.6	63.39	16.941
30..	75.74	17.7	64.43	17.213	24..	76.10	18.0	63.12	16.849
31..	76.34	18.0	64.37	17.183	31..	76.17	18.0	62.90	16.790

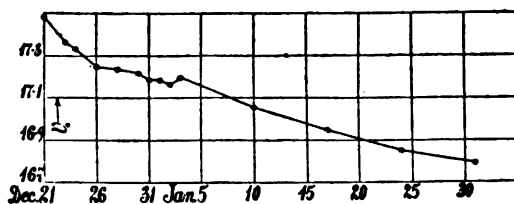

FIG. 25.—Chart showing loss of standard volumes of gas in diver in lapse of days. Diffusion of air through KCl solution.

The rates of diffusion are

$$\dot{v}_0 = 0.0145 \text{ c.c./day or } 10^{10}\kappa = 0.256$$

There has thus been a retrogression of rates, while the other diffusions in the same region behaved normally. The rate is still far from the large value corresponding to pure water.

47. Diffusion of Air into Air Through NaCl Solution.—The experiments were made in vessel *F*, the original solution being nearly concentrated. The density was $\rho_w = 1.1450$ at 22° , equivalent to 19.6 grams in 100 grams of solution or to 24.4 grams in 100 grams of water. The vapor pressures were taken as $\pi' = \pi (1 - 0.157)$.

The current data are given in table 28 and fig. 26 A.

Fig. 26 A shows a fairly regular progress of results and the constants are

$$\dot{v}_0 = 0.0035 \text{ c.c./day or } 10^{10}\kappa = 0.088$$

showing very slow diffusion.

TABLE 28.—Air-air through brine (24.4 grams in 100 grams water). Single-tube vessel. $M = 10.9387$ grams; $C = 39.294$; $\rho_g = 2.466$; float, $2r = 3.00$ cm.; vessel, $2r = 4.7$ cm.; $\rho_w = 1.145$ at 22° .

Date.	Barometer.	<i>t</i>	<i>H</i>	<i>v</i> ₀	Date.	Barometer.	<i>t</i>	<i>H</i>	<i>v</i> ₀
		°					°		
Nov. 12..	75.85	19.0	72.95	4.587	Dec. 3..	76.45	16.5	71.48	4.530
13..	76.17	18.8	73.09	4.599	4..	76.30	16.6	71.51	4.530
14..	75.69	18.8	73.20	4.606	5..	77.06	17.0	71.51	4.525
15..	75.72	18.8	73.21	4.607	6..	75.75	17.3	71.64	4.529
16..	76.52	18.5	73.12	4.606	7..	76.14	17.7	71.63	4.522
18..	76.26	18.0	72.88	4.598	9..	76.28	17.7	71.63	4.522
19..	76.29	17.7	72.79	4.596	10..	76.33	17.7	71.53	4.516
20..	75.97	17.7	72.61	4.584	11..	75.92	17.3	71.54	4.523
21..	76.31	17.3	72.48	4.582	12..	76.16	17.4	71.33	4.508
22..	75.94	17.3	72.43	4.579	13..	77.10	17.2	71.27	4.507
23..	76.08	17.5	72.53	4.582	14..	76.74	17.0	71.26	4.509
25..	74.91	17.3	72.47	4.582	16..	75.40	16.9	71.11	4.501
26..	76.20	17.3	72.40	4.577	17..	76.45	17.1	70.94	4.487
27..	76.38	17.1	72.19	4.566	18..	76.40	17.2	70.65	4.467
29..	76.95	16.6	71.96	4.559	19..	74.34	17.3	70.67	4.468
30..	76.79	16.6	71.64	4.538	20..	75.88	17.3	70.65	4.467
Dec. 2..	76.60	16.4	71.44	4.529					

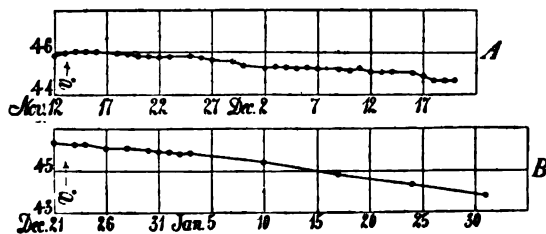

FIG. 26 A, B.—Chart showing loss of standard volumes of gas in diver in lapse of days. Diffusion of air through NaCl solution.

48. **The Same, Continued.**—On dilution with about an equal bulk of water the density was $\rho = 1.0680$ at 21° , corresponding to 9.5 grams in 100 grams of solution or 10.5 grams in 100 grams of water. The vapor pressure was $\pi' = \pi(1 - 0.060)$.

The record of results is contained in table 29 and fig. 26 B. The march of values as a whole is very regular, particularly when the daily observations are replaced by weekly observations. The rates of diffusion are

$$\dot{v}_0 = 0.00725 \text{ c.c./day or } 10^{10} \kappa = 0.192$$

showing a normal increase of rates toward the value for pure water.

TABLE 29.—Air into air through NaCl solution (10.5 grams in 100 grams water). Vessel F. Constants as in table 28. $\rho_w = 1.0680$ at 21° .

Date.	Barometer.	t	H	v_0	Date.	Barometer.	t	H	v_0
		°					°		
Dec. 21..	76.57	17.5	64.60	4.632	Jan. 1..	76.01	17.8	64.00	4.585
23..	76.75	17.4	64.46	4.624	2..	76.87	18.0	63.94	4.578
24..	75.70	17.2	64.44	4.624	3..	73.98	18.1	63.99	4.580
26..	77.10	17.1	64.12	4.603	10..	77.35	17.6	63.26	4.534
28..	75.50	17.1	64.13	4.604	17..	76.54	17.3	62.40	4.477
30..	75.74	17.3	64.05	4.596	24..	76.10	17.7	61.82	4.430
31..	76.34	17.6	63.99	4.587	31..	76.17	17.7	61.12	4.379

49. **Diffusion of Air into Air Through CaCl_2 Solution.**—This solution was prepared by putting 140 grams of approximately anhydrous calcic chloride in 400 c.c. of water. Its density was found to be 1.1922 at 24.9°C . A table of densities between 16° and 25° was computed, as before. The solution actually contained about 21.4 grams of CaCl_2 in 100 grams of solution, or 27.2 grams of salt in 100 grams of water. In endeavoring to obtain the vapor pressure π' above the solution, some difficulty was encountered. By graphic interpolation for the given concentration, the data at 0°C . from Dieterici's observations should be $\pi' = \pi(1 - 0.198)$. The results of Tammann made at considerably higher temperatures would give $\pi(1 - 0.145)$ for the same solution. The former result was assumed, as the temperature of observation was nearer 0°C . The effect on the diffusion coefficient is of no consequence. The daily observations are given in table 30 and fig. 27.

The diffusion of air through strong solution of CaCl_2 is not of an abnormal character, except in the temperature fluctuations. The rates of diffusion (obtained by a mean line passed through the observations) are

$$\dot{v}_0 = 0.0062 \text{ c.c./day} \quad 10^{10} \kappa = 0.213$$

being again much less than the normal value for the air-water system. The physical pores of the liquid are thus virtually still much smaller.

It is important to note that notwithstanding the greater concentration of the calcic chloride solution, diffusion proceeds more rapidly than for the weaker solution of KCl. In other words, the virtual stoppage is much more effective, *cat. par.*, in the case of KCl than in the case of CaCl_2 , as far as can yet be foreseen. True, it seems possible that all comparisons will have to be made with the same apparatus, as each may have its own constants.

TABLE 30.—Air-air through CaCl_2 solution (27.2 grams in 100 grams water). Vessel C (single tube). $M=14.448$ grams; $\rho_0=2.487$; $C=51.91$; $\rho_w=1.1922$ at 24.9° ; float, $2r=2.85$ cm.; vessel, $2r=4.6$ cm.

Date.	Barom-eter.	t	H	v_0	Date.	Barom-eter.	t	H	v_0
		°					°		
Sept. 19..	75.85	21.5	70.24	5.399	Oct. 7..	75.68	19.2	67.16	5.199
20..	76.03	22.5	70.47	5.401	8..	76.34	19.8	67.12	5.187
21..	76.90	18.8	69.52	5.388	9..	76.78	21.5	67.35	5.177
23..	76.81	17.0	68.74	5.358	10..	76.27	23.0	67.54	5.168
24..	77.00	17.4	68.57	5.338	11..	76.72	21.9	67.47	5.180
25..	76.72	17.6	68.51	5.330	12..	76.40	22.8	67.44	5.163
26..	76.54	17.6	68.41	5.323	14..	76.88	22.6	67.28	5.155
27..	76.31	17.6	68.22	5.308	15..	76.08	22.5	67.21	5.151
28..	77.04	19.0	68.34	5.294	16..	76.92	20.0	66.58	5.141
30..	76.90	17.4	68.03	5.296	17..	76.44	20.6	66.56	5.131
Oct. 1..	76.03	18.0	67.53	5.247	18..	76.38	22.4	66.90	5.128
2..	76.58	18.2	67.44	5.236	19..	75.97	22.2	66.82	5.125
3..	76.33	20.5	68.20	5.257	21..	77.29	21.4	66.50	5.112
4..	76.10	22.8	68.11	5.215	22..	77.08	21.3	66.41	5.107
5..	76.69	20.8	67.60	5.207	23..	76.05	22.3	66.58	5.105

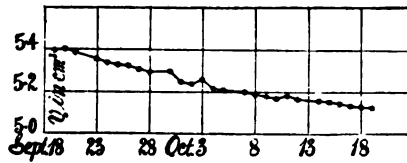

FIG. 27.—Chart showing loss of standard volumes of gas in diver in lapse of days. Diffusion of air through CaCl_2 solution.

TABLE 31.—Air-air through CaCl_2 solution (13.9 grams in 100 grams water). Vessel C (single tube). Constants as in table 30. $\rho_w=1.105$ at 23° .

Date.	Barom-eter.	t	H	v_0	Date.	Barom-eter.	t	H	v_0
		°					°		
Oct. 26..	75.66	22.5	65.64	5.797	Nov. 7..	76.02	24.0	64.91	5.707
28..	76.20	21.3	65.27	5.786	8..	75.07	23.9	65.00	5.717
29..	76.58	20.2	64.92	5.774	9..	75.55	19.0	63.95	5.709
30..	75.80	21.7	65.09	5.763	11..	76.33	19.0	63.62	5.680
Nov. 1..	75.91	19.8	64.56	5.750	12..	75.85	18.9	63.59	5.679
2..	75.62	20.5	64.60	5.741	13..	76.17	18.9	63.48	5.669
4..	77.33	17.8	63.64	5.705	14..	75.69	19.0	63.42	5.662
5..	76.89	20.5	64.06	5.693	15..	75.72	19.0	63.27	5.648
6..	76.82	22.2	64.52	5.703	16..	76.52	18.7	63.22	5.650

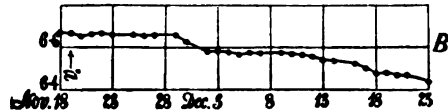

FIG. 28 A, B.—Chart showing loss of standard volumes of gas in diver in lapse of days. Diffusion of air through CaCl_2 solution.

But the following data for dilute solutions of CaCl_2 in the same vessel will exhibit much more striking anomalies in this respect.

50. The Same, Continued.—The preceding solution, being diluted with about an equal bulk of water, showed a density of 1.105 at 23° . This is equivalent to 12.2 grams in 100 grams of solution, or 13.9 grams in 100 grams of water. The vapor pressures are correspondingly increased to $\pi' = \pi(1 - 0.075)$, for which tables were computed. The diffusion results are given in table 31 and fig. 28 A, the apparatus and equipment being otherwise the same. The mean rate of diffusion corresponds to the following data, again adducing a small increase of κ as compared with the former solution.

$$\dot{v}_0 = 0.0072 \text{ c.c./day and } 10^{10}\kappa = 0.352$$

The curve shows no initial disturbances.

51. The Same, Continued.—The solution was then further diluted to about one-half, *i. e.*, to about one-quarter of its original strength. The density found was 1.058 at 18°C ., which is equivalent to about 7.1 grams CaCl_2 in 100 grams of solution or about 7.6 grams CaCl_2 in 100 grams of water. The vapor pressures were therefore taken as $\pi' = \pi(1 - 0.042)$.

The record of results is given in table 32 and fig. 28 B.

TABLE 32.—Air-air through CaCl_2 solution (7.6 grams in 100 grams water). Vessel C (single tube). Constants as in table 30. $\rho_w = 1.058$ at 18° .

Date.	Barometer.	t	H	v_0	Date.	Barometer.	t	H	v_0
		°					°		
Nov. 18..	76.26	18.0	68.88	6.673	Dec. 6..	75.75	17.3	67.74	6.577
19..	76.29	17.8	68.78	6.668	7..	76.14	17.8	67.77	6.570
20..	75.97	17.6	68.65	6.658	9..	76.28	17.8	67.81	6.574
21..	76.31	17.3	68.69	6.669	10..	76.33	17.8	67.76	6.569
22..	75.94	17.3	68.70	6.670	11..	75.92	17.5	67.64	6.563
23..	76.08	17.5	68.66	6.662	12..	76.16	17.6	67.54	6.551
25..	74.91	17.5	68.69	6.664	13..	77.10	17.3	67.31	6.535
26..	76.20	17.3	68.59	6.659	14..	76.74	17.0	67.24	6.534
27..	76.38	17.1	68.58	6.662	16..	75.40	17.0	67.10	6.520
29..	76.95	16.7	68.48	6.660	17..	76.45	17.2	66.96	6.502
30..	76.79	16.6	68.13	6.628	18..	76.40	17.3	66.67	6.473
Dec. 2..	76.60	16.7	67.66	6.580	19..	74.34	17.5	66.79	6.480
3..	76.45	16.5	67.63	6.582	20..	75.88	17.6	66.65	6.464
4..	76.30	16.7	67.65	6.579	21..	76.57	17.7	66.65	6.462
5..	77.06	17.0	67.59	6.568	23..	76.75	17.4	66.27	6.432

The mean rate of diffusion would correspond to

$$\dot{v}_0 = 0.0067 \text{ c.c./day or } 10^{10}\kappa = 0.254$$

which is actually *smaller* than the constant for the half strength of solution.

The final rate, however, is

$$\dot{v}_0 = 0.0097 \text{ c.c./day or } 10^{10}\kappa = 0.368$$

a slight increase on the preceding rate. It is probable, therefore, that the first rate was obtained in the absence of equilibrium conditions. The curve shows marked initial disturbances, there being no effective diffusion within the first ten days.

52. The Same, Continued.—The preceding solution diluted with an equal bulk of water showed the density $\rho = 1.0274$ at 21° or 3.3 grams in 100 grams of solution, 3.4 grams in 100 grams of water, corresponding to the vapor pressure $\pi' = \pi(1 - 0.018)$.

The record of results is contained in table 33 and fig. 29 and is very peculiar. Even apart from the usual irregularity at the beginning of the observation period, the curve continues to be sinuous after the weekly method of observation is introduced. The mean value is probably that of pure water, though the whole behavior is abnormal. The mean diffusion rates are

$$\dot{v}_0 = 0.025 \text{ c.c./day or } 10^{10}\kappa = 0.946$$

a value even in excess of the usual air value. If the final rate were taken the diffusion constants would be

$$\dot{v}_0 = 0.0197 \text{ c.c./day or } 10^{10}\kappa = 0.744$$

which is more nearly the probable result.

TABLE 33.—Air into air through CaCl_2 solution (3.4 grams in 100 grams water). Vessel C. Constants as in table 30. $\rho_w = 1.0274$ at 21° .

Date.	Barometer.	t	H	v_0	Date.	Barometer.	t	H	v_0
		0					0		
Dec. 26..	77.10	17.1	67.55	6.895	Jan. 3..	73.98	18.2	67.48	6.865
28..	75.50	17.0	67.55	6.898	10..	77.35	17.7	66.05	6.729
30..	75.74	17.3	67.58	6.895	17..	76.54	17.2	63.53	6.483
31..	76.34	17.7	67.55	6.882	24..	76.10	17.8	62.01	6.317
Jan. 1..	76.01	17.9	67.50	6.874	31..	76.17	17.9	60.89	6.201
2..	76.87	18.0	67.34	6.855					

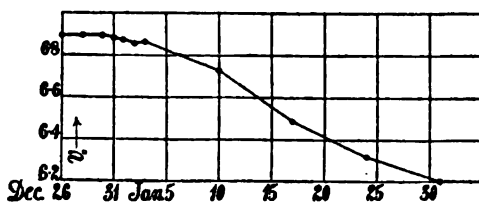

FIG. 29.—Chart showing loss of standard volumes of gas in diver in lapse of days. Diffusion of air through CaCl_2 solution.

53. Diffusion of Air into Air Through BaCl_2 Solution.—The present results are to be compared in series with the calcic and strontic chlorides. The concentrated solution of BaCl_2 showed a density of $\rho_w = 1.170$ at 20°C ., therefore equivalent to 17 grams of BaCl_2 in 100 grams of solution or 20.5 grams in 100 grams of water. The vapor pressure was taken as $\pi' = \pi(1 - 0.050)$. The results obtained are recorded in table 34 and fig. 30A.

A line drawn through the observations gives the rates

$$\dot{v}_0 = 0.0077 \text{ c.c./day or } 10^{10}\kappa = 0.192$$

low values, in keeping with the concentrated solution.

TABLE 34.—Air-air through BaCl₂ solution (20.5 grams in 100 grams water). Single-tube vessel. $M=7.4960$ grams; $C=26.926$; $\rho_g=2.470$; $\rho_w=1.170$ at 23° ; float, $2r=3.00$ cm.; vessel, $2r=4.7$ cm.

Date.	Barom-eter.	t	H	v_0	Date.	Barom-eter.	t	H	v_0
		°					°		
Nov. 8..	75.07	24.0	70.19	2.864	Nov. 16..	76.52	18.7	67.21	2.787
9..	75.55	19.0	68.90	2.854	18..	76.26	18.0	66.59	2.767
11..	76.33	19.0	68.11	2.821	19..	76.29	17.7	66.31	2.758
12..	75.85	19.0	67.87	2.811	20..	75.97	17.5	66.09	2.751
13..	76.17	19.0	67.64	2.802	21..	76.31	17.3	65.86	2.743
14..	75.69	19.0	67.57	2.799	22..	75.94	17.4	65.80	2.739
15..	75.72	19.0	67.27	2.787	23..	76.08	17.5	65.69	2.734

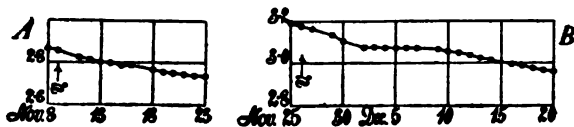

FIG. 30 A, B.—Chart showing loss of standard volumes of gas in diver in lapse of days. Diffusion of air through BaCl₂ solution.

54. The Same, Continued.—The solution was now diluted one-half and tested in the same vessel. The density was $\rho_w=1.0886$ at 21° , implying about 9.6 grams in 100 grams of solution or 10.6 grams in 100 grams of water. This corresponds to the vapor pressure $\pi'=\pi(1-0.050)$. Table 35 and fig. 30 B record the results obtained, which are fairly regular, except at the beginning, where the conditions of equilibrium are being slowly approached. The mean constants are

$$\bar{v}_0=0.0082 \text{ c.c./day or } 10^{10}\kappa=0.225$$

a slight increase on the preceding values, showing that the effect of dilution as usual is at first not marked.

TABLE 35.—Air-air through BaCl₂ solution (10.6 grams in 100 grams water). Single tube vessel. Constants as in table 34. $\rho_w=1.0886$ at 21° .

Date.	Barom-eter.	t	H	v_0	Date.	Barom-eter.	t	H	v_0
		°					°		
Nov. 25..	74.91	17.3	67.11	3.194	Dec. 9..	76.28	17.8	64.51	3.066
26..	76.20	17.3	66.80	3.179	10..	76.33	17.8	64.27	3.054
27..	76.38	17.1	66.49	3.166	11..	75.92	17.5	64.12	3.049
29..	76.95	16.6	65.81	3.138	12..	76.16	17.6	63.93	3.039
30..	76.79	16.6	65.16	3.107	13..	77.10	17.3	63.57	3.025
Dec. 2..	76.60	16.5	64.51	3.077	14..	76.74	17.1	63.27	3.013
3..	76.45	16.5	64.53	3.078	16..	75.40	17.1	62.93	2.996
4..	76.30	16.7	64.44	3.073	17..	76.45	17.2	62.77	2.988
5..	77.06	17.0	64.50	3.072	18..	76.40	17.3	62.51	2.975
6..	75.75	17.4	64.60	3.073	19..	74.34	17.4	62.36	2.967
7..	76.14	17.8	64.62	3.071	20..	75.88	17.4	62.22	2.960

55. The Same, Continued.—The dilution of the preceding solution with about an equal bulk of water showed the density $\rho = 1.0435$ at 21° , or 4.83 grams in 100 grams of solution, 5.1 grams in 100 grams of water, the vapor pressure being $\pi' = \pi(1 - 0.010)$.

The record of results is given in table 36 and fig. 31, and is throughout reasonably regular, particularly after the weekly period of observations has been installed. The diffusion constants are

$$\dot{v}_0 = 0.00875 \text{ c.c./day or } 10^{10}k = 0.244.$$

which is still far removed from water.

TABLE 36.—Air into air through BaCl_2 solution (5.1 grams in 100 grams water). Single-tube vessel. Constants as in table 34. $\rho_w = 1.0435$ at 21° .

Date.	Barom-eter.	t	H	v_0	Date.	Barom-eter.	t	H	v_0
		°					°		
Dec. 21..	76.57	17.5	63.39	3.248	Jan. 2..	76.87	17.9	60.07	3.074
23..	76.75	17.3	61.70	3.164	3..	73.98	18.0	60.14	3.077
26..	77.10	17.1	60.78	3.118	10..	77.35	17.5	58.58	3.002
28..	75.50	17.1	60.94	3.126	17..	76.54	17.2	57.16	2.931
30..	75.74	17.3	60.45	3.099	24..	76.10	17.6	56.57	2.898
31..	76.34	17.6	60.37	3.092	31..	76.17	17.6	55.74	2.855
Jan. 1..	76.01	17.8	60.32	3.088					

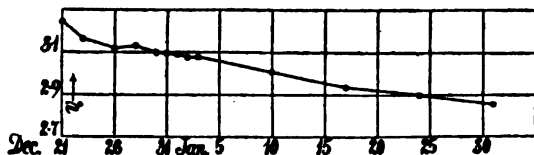

FIG. 31.—Chart showing loss of standard volumes of gas in diver in lapse of days. Diffusion of air through BaCl_2 solution.

56. Diffusion of Air into Air Through K_2SO_4 Solution.—This solution is the first of the sulphates and is to be compared with sodic sulphate and possibly with the alums. The solution of K_2SO_4 showed a density of $\rho_w = 1.065$ at 23° , corresponding therefore to 8 grams of K_2SO_4 in 100 grams of solution or 8.7 grams in 100 grams of water. The vapor pressure was taken as $\pi' = \pi(1 - 0.017)$. The results are given in table 37 and fig. 32 A.

A line drawn through the observations corresponds to the following slope:

$$\dot{v}_0 = 0.0137 \text{ c.c./day or } 10^{10}k = 0.401$$

The small effect is in keeping with the essentially dilute solution of a not very soluble salt.

57. The Same, Continued.—This solution of K_2SO_4 was diluted to about one-half and the resulting density found to be 1.0315 at 19° , which is equivalent to 4 grams of K_2SO_4 in 100 grams of solution or 4.2 grams in 100 grams of water. Hence the vapor pressures are $\pi' = \pi(1 - 0.008)$. The record of results is given in table 38 and fig. 32 B.

The mean diffusion rates correspond to

$$\dot{v}_0 = 0.0100 \text{ c.c./day or } 10^{10}k = 0.322$$

TABLE 37.—Air-air through K_2SO_4 solution (8.7 grams in 100 grams water). Single-tube vessel. $M=8.6430$ grams; $C=31.046$; $\rho_g=2.470$; $\rho_w=1.065$ at 23° ; float, $2r=3.03$ cm.; vessel, $2r=4.7$ cm.

Date.	Barometer.	t	H	v_0	Date.	Barometer.	t	H	v_0
		°					°		
Nov. 8..	75.07	24.0	70.90	3.960	Nov. 20..	75.97	17.5	65.07	3.707
9..	75.55	19.0	69.49	3.941	21..	76.31	17.3	64.84	3.697
11..	76.33	19.0	68.39	3.879	22..	75.94	17.4	64.74	3.690
12..	75.85	19.0	67.96	3.854	23..	76.08	17.5	64.65	3.683
13..	76.17	19.0	67.64	3.836	25..	74.91	17.3	64.55	3.680
14..	75.69	19.0	67.37	3.821	26..	76.20	17.3	64.22	3.661
15..	75.72	19.0	66.94	3.796	27..	76.38	17.1	63.92	3.646
16..	76.52	18.7	66.57	3.779	29..	76.95	16.6	63.34	3.619
18..	76.26	18.0	65.77	3.741	30..	76.79	16.6	62.74	3.584
19..	76.29	17.7	65.44	3.726					

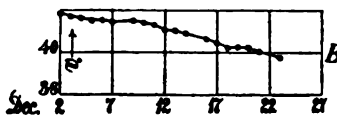
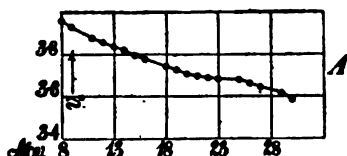

FIG. 32 A, B.—Chart showing loss of standard volumes of gas in diver in lapse of day. Diffusion of air through K_2SO_4 solution.

The final diffusions are given by

$$\bar{v}_0 = 0.0120 \text{ c.c./day or } 10^{10} \kappa = 0.388$$

Both data for κ , strangely enough, correspond to a decrease of the original rates for a concentrated solution. As in many other cases to be exemplified, the effect of dilution is thus of a complicated nature, seeing that the pores of a dilute solution may be smaller than those of a more concentrated solution.

TABLE 38.—Air-air through K_2SO_4 solution (4.2 grams in 100 grams water). Single-tube vessel. Constants as in table 37. $\rho_w=1.0315$ at 19° .

Date.	Barometer.	t	H	v_0	Date.	Barometer.	t	H	v_0
		°					°		
Dec. 2..	76.60	16.5	69.23	4.188	Dec. 13..	77.10	17.3	68.00	4.104
3..	76.45	16.5	68.95	4.171	14..	76.74	17.1	67.74	4.090
4..	76.30	16.7	68.90	4.165	16..	75.40	17.1	67.32	4.065
5..	77.06	17.0	68.74	4.152	17..	76.45	17.2	67.07	4.048
6..	75.75	17.4	68.86	4.154	18..	76.40	17.3	66.66	4.023
7..	76.14	17.8	68.85	4.149	19..	74.34	17.4	66.78	4.029
9..	76.28	17.8	68.90	4.152	20..	75.88	17.4	66.66	4.022
10..	76.33	17.8	68.72	4.141	21..	76.57	17.5	66.45	4.007
11..	75.92	17.5	68.48	4.130	23..	76.75	17.3	65.85	3.974
12..	76.16	17.6	68.16	4.109					

58. The Same, Continued.—On further dilution with about an equal volume of water the density was 1.0136 at 20° , corresponding to 1.7 grams in 100 grams of solution, or 1.7 grams in 100 grams of water. The vapor pressure was $\pi' = \pi (1 - 0.003)$.

The record of diffusion is given in table 39 and fig. 33. It is throughout nearly regular and corresponds to the rates

$$\dot{v}_0 = 0.0100 \text{ c.c./day or } 10^{10} \kappa = 0.302$$

which is less than the preceding case and still far distant from the value for pure water. The advantage of the weekly period of observations is obvious.

TABLE 39.—Air into air through K_2SO_4 solution (1.7 grams in 100 grams water). Single-tube vessel. Constants as in table 37. $\rho_w = 1.0136$ at 20° .

Date.	Barometer.	t	H	v_0	Date.	Barometer.	t	H	v_0
		°					°		
Dec. 26..	77.10	17.1	69.05	4.294	Jan. 3..	73.98	18.0	67.36	4.178
28..	75.50	17.1	68.35	4.251	10..	77.35	17.5	66.01	4.100
30..	75.74	17.3	67.71	4.209	17..	76.54	17.3	64.78	4.027
31..	76.34	17.6	67.60	4.198	24..	76.10	17.6	63.86	3.965
Jan. 1..	76.01	17.8	67.49	4.189	31..	76.17	17.6	62.73	3.895
2..	76.87	17.9	67.25	4.172					

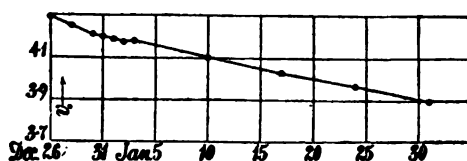

FIG. 33.—Chart showing loss of standard volumes of gas in diver in lapse of days. Diffusion of air through K_2SO_4 solution.

59. Diffusion of Air into Air Through Na_2SO_4 Solution.—This solution was prepared for comparison with K_2SO_4 , though unfortunately neither is very soluble. The density of the Na_2SO_4 was found to be $\rho_w = 1.1160$ at 20° , implying 13.7 grams in 100 grams of solution or 15.9 grams in 100 grams of water. The vapor pressures were taken as $\pi' = \pi(1 - 0.035)$.

TABLE 40.—Air-air through Na_2SO_4 solution (15.9 grams in 100 grams water). Vessel E (single tube). Constants as in table 20. $\rho_w = 1.1160$ at 20° .

Date.	Barometer.	t	H	v_0	Date.	Barometer.	t	H	v_0
		°					°		
Nov. 25..	74.91	17.3	68.53	5.182	Dec. 10..	76.33	17.6	67.65	5.111
26..	76.20	17.3	68.52	5.181	11..	75.92	17.3	67.51	5.105
27..	76.38	17.1	68.44	5.179	12..	76.16	17.4	67.42	5.096
29..	76.95	16.6	68.18	5.167	13..	77.10	17.2	67.23	5.085
30..	76.79	16.6	67.81	5.139	14..	76.74	17.0	67.12	5.081
Dec. 2..	76.60	16.4	67.53	5.121	16..	75.40	17.0	66.99	5.071
3..	76.45	16.3	67.58	5.127	17..	76.45	17.2	66.83	5.055
4..	76.30	16.6	67.63	5.125	18..	76.40	17.3	66.67	5.041
5..	77.06	16.9	67.56	5.116	19..	74.34	17.5	66.64	5.037
6..	75.75	17.3	67.73	5.122	20..	75.88	17.5	66.39	5.018
7..	76.14	17.7	67.73	5.115	21..	76.57	17.5	66.24	5.006
9..	76.28	17.7	67.70	5.113	23..	76.75	17.2	65.99	4.992

Table 40 and fig. 34 A record the results. The diffusion in the main proceeds in accordance with

$$\dot{v}_0 = 0.0070 \text{ c.c./day or } 10^{10}\kappa = 0.168$$

and the rates finally obtained are

$$\dot{v}_0 = 0.0095 \text{ c.c./day or } 10^{10}\kappa = 0.229$$

The usual difficulties in relation to equilibrium conditions assert themselves at the outset.

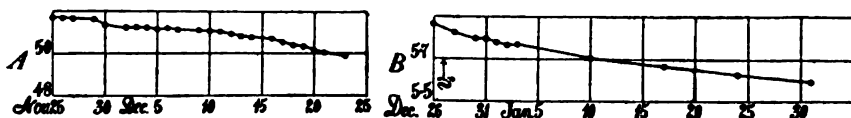

FIG. 34 A, B.—Chart showing loss of standard volumes of gas in diver in lapse of days. Diffusion of air through Na_2SO_4 solution.

60. **The Same, Continued.**—Diluted with about an equal bulk of water the density of the solution fell to $\rho = 1.0580$ at 21° , corresponding to 6.32 grams in 100 grams of solution or 6.75 grams in 100 grams of water. The vapor pressure is $\pi' = \pi(1 - 0.014)$.

TABLE 41.—Air into air through Na_2SO_4 solution (6.75 grams in 100 grams water). Vessel E. Constants as in table 40. $\rho_w = 1.0580$ at 21° .

Date.	Barom-eter.	t	H	v_0	Date.	Barom-eter.	t	H	v_0
		o					o		
Dec. 26..	77.10	17.1	70.46	5.864	Jan. 3..	73.98	17.9	69.48	5.767
28..	75.50	17.1	69.96	5.822	10..	77.35	17.5	68.58	5.701
30..	75.74	17.3	69.70	5.796	17..	76.54	17.2	68.08	5.664
31..	76.34	17.4	69.68	5.793	24..	76.10	17.6	67.68	5.624
Jan. 1..	76.01	17.7	69.54	5.776	31..	76.17	17.5	67.30	5.594
2..	76.87	17.8	69.42	5.764					

The observations are given in table 41 and fig. 34 B. They are reasonably regular and show that the weekly period of observations is in every way preferable to the daily period. The rates of diffusion are

$$\dot{v}_0 = 0.0065 \text{ c.c./day or } 10^{10}\kappa = 0.164.$$

which is still far below the value for pure water, in spite of the dilution of the solution in question.

61. **Diffusion of Air into Air Through FeCl_3 Solution.**—A nearly concentrated solution of this very soluble salt was prepared, showing the density 1.2510 at 22° and corresponding to 27.3 grams in 100 grams of solution, or 37.5 grams in 100 grams of water. A table for the vapor pressures above the solution could not be found. The data for CaCl_2 were, therefore, provisionally adopted, as the effect upon κ is not relatively large, when compared with the other inevitable errors. Hence the vapor pressures are $\pi' = \pi$

(1-0.255). The curve obtained for the progress of diffusion is a line nearly horizontal, showing a liquid all but impervious so far as the air molecule is concerned. The slopes of the curve, table 42, fig. 35 A, correspond to

$$\dot{v}_0 = 0.00125 \text{ c.c./day or } 10^{10}\kappa = 0.045$$

the smallest value thus far obtained. Though a comparison with AlCl_3 is intended, it must be remembered that the apparatus is the one with the long diver and liable to show relatively small results.

TABLE 42.—Air-air through FeCl_3 solution (37.5 grams in 100 grams water). Vessel *H* (single tube). $\rho_w = 1.2510$ at 22° . Constants as in table 23.

Date.	Barometer.	<i>t</i>	<i>H</i>	<i>v</i> ₀	Date.	Barometer.	<i>t</i>	<i>H</i>	<i>v</i> ₀
		°					°		
Dec. 2..	76.60	17.5	67.47	3.823	Dec. 16..	75.40	17.9	67.85	3.840
3..	76.45	17.3	67.61	3.833	17..	76.45	17.8	67.77	3.837
4..	76.30	17.5	67.56	3.828	18..	76.40	17.9	67.51	3.821
5..	77.06	17.8	67.66	3.830	19..	74.34	18.0	67.72	3.831
6..	75.75	18.2	67.78	3.832	20..	75.88	18.2	67.58	3.821
7..	76.14	18.6	67.85	3.832	21..	76.57	18.1	67.56	3.821
9..	76.28	18.6	67.99	3.840	23..	76.75	17.9	67.42	3.816
10..	76.33	18.6	67.97	3.838	24..	75.70	17.8	67.42	3.817
11..	75.92	18.2	68.03	3.846	26..	77.10	17.8	67.23	3.806
12..	76.16	18.4	67.99	3.841	28..	75.50	17.9	67.36	3.812
13..	77.10	18.0	67.95	3.844	30..	75.74	18.1	67.38	3.811
14..	76.74	17.9	68.06	3.852					

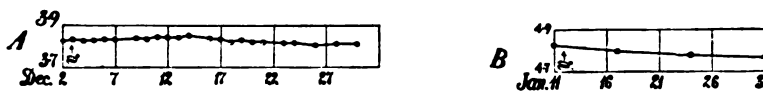

FIG. 35 A, B.—Charts showing loss of standard volumes of gas in diver in lapse of days. Diffusion of air through FeCl_3 solution.

62. **The Same, Continued.**—The preceding solution was now diluted with an equal bulk of water. The density was thus reduced to 1.1260 at 24° , corresponding to about 14.3 grams in 100 grams of solution or 16.7 grams in 100 grams of water. Thus the provisional vapor pressures are $\pi' = \pi(1 - 0.095)$. The record of results is contained in table 43 and fig. 35 B.

TABLE 43.—Air into air through FeCl_3 solution (16.7 grams in 100 grams water). Vessel *H*. Constants as in table 42. $\rho_w = 1.1260$ at 24° .

Date.	Barometer.	<i>t</i>	<i>H</i>	<i>v</i> ₀	Date.	Barometer.	<i>t</i>	<i>H</i>	<i>v</i> ₀
		°					°		
Jan. 11..	76.28	17.9	69.61	4.823	Jan. 24..	76.10	18.2	69.00	4.779
17..	76.54	17.9	69.26	4.799	31..	76.17	18.2	68.76	4.762

The rates of diffusion correspond to

$$\dot{v}_0 = 0.00275 \text{ c.c./day or } 10^{10}\kappa = 0.094$$

Observations were taken but once a week with an obvious advantage to the smoothness of the curve. The ratio is here remarkably linear.

63. Diffusion of Air into Air Through AlCl_3 Solution.—This is the original solution of the series and nearly concentrated, the density being $\rho = 1.1550$ at 19° , corresponding to 20.2 grams in 100 grams of solution or 25.3 grams in 100 grams of water. The vapor pressure, for want of specific data, was taken the same as CaCl_2 and is thus $\pi' = \pi(1 - 0.177)$.

TABLE 44.—Air into air through AlCl_3 solution (25.3 grams in 100 grams water). Vessel A (single tube). Constants as in table 16. $\rho_w = 1.1550$ at 19° .

Date.	Barom-eter.	t	H	v_0	Date.	Barom-eter.	t	H	v_0
		o					o		
Dec. 26..	77.10	17.0	71.46	4.921	Jan. 3..	73.98	17.9	71.25	4.892
28..	75.50	17.0	71.21	4.904	10..	77.35	17.4	70.95	4.879
30..	75.74	17.2	71.38	4.912	17..	76.54	17.1	70.62	4.861
31..	76.34	17.5	71.41	4.910	24..	76.10	17.4	70.45	4.845
Jan. 1..	76.01	17.7	71.44	4.909	31..	76.17	17.5	70.34	4.836
2..	76.87	17.8	71.43	4.906					



Fig. 36.—Chart showing loss of standard volumes of gas in diver in lapse of days. Diffusion of air through AlCl_3 solution.

The record of results is contained in table 44 and fig. 36 and is largely completed in weekly periods. The diffusion is slow and reasonably regular, showing the rates

$$\dot{v}_0 = 0.00225 \text{ c.c./day or } 10^{10} \kappa = 0.076$$

a very low value in correspondence with the density of solution.

64. Diffusion of a Gas Through a Manometer Tube.—This method of finding the coefficient of diffusion is necessarily excessively slow. It was installed merely as a corroboration of the above data for κ , which it was supposed to reproduce in order of value.

In fig. 37, ab is a manometer tube about 0.6 cm. internal diameter, closed at both ends and containing about the same volume of air, ac and bd , at each end of the liquid cb . In this way the effect of temperature is diminished, though it is necessary to observe a nearly constant temperature, since the liquid invariably expands.

This tube with a thermometer was placed in a vault, to be observed in the lapse of years, more than one of which has since gone by. The excursion of the two ends of the liquid column are separately read off, c rising and b falling by less than a millimeter in a year. Glass scales were attached to the shanks of the tube for this purpose.

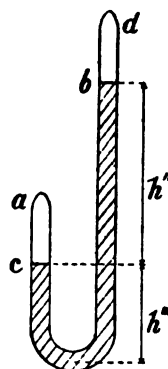

FIG. 37.—Closed manometer adjusted for diffusion of air through water.

Table 45 shows the results as thus far obtained.

To compute κ , the coefficient of volume diffusion, the equation becomes

$$\kappa = \dot{v}/a(dp/dl) = \dot{h}(1 + 2h'''/h'')/\rho g$$

where \dot{h} is the rise per second of the lower meniscus and the fall per second of the upper, h'' the head of liquid of density ρ , $2h''' + h''$ the total length of column through which diffusion takes place. The table shows that on the average $\dot{h} = 26.45 - 26.37 = 0.08$ cm. below, and $16.27 - 16.20 = 0.07$ cm. above, in about $17\frac{1}{2}$ months, or 45.6×10^6 seconds. Hence

$$\dot{h} = \frac{0.075}{46 \times 10^6} \text{ while } 1 + \frac{2h'''}{h''} = 1 + \frac{9.4}{10.2} \text{ and } \rho g = 981$$

Therefore $\kappa = 0.03 \times 10^{-10}$ nearly, a value, even in consideration of the long time of observation, 17 months, and the small displacement of meniscus, surprisingly below the datum furnished by experiments with the Cartesian diver above, $\kappa = 0.8 \times 10^{-10}$.

TABLE 45.—Diffusion in U-tube.

Date.	t	Level below.	Level above.	Diff.	Date.	t	Level below.	Level above.	Diff.
1911.	°				1912.	°			
April 19..	18.5	26.40	16.20	10.20	Oct. 6..	19.0	26.35	16.25	10.10
23..	15.0	26.48	16.20	10.28	24..	20.0	26.38	16.28	10.10
30..	17.0	26.48	16.20	10.28	Dec. 31..	18.5	26.37	16.27	10.10
May 7..	17.8	26.48	16.20	10.28					
28..	20.0	26.42	16.22	10.20					

This experiment shows that, so far as the manometer is concerned, the diffusion error will be negligible. It is by no means so, however, when it is a question of storing a pure gas over water in air.

Nothing, however, has been brought forward to suggest why this direct result for κ with the manometer should be but 4 per cent of the value found by the diver, unless it be the continual or intermittent churning up of gradients by temperature, and by the diver in the latter case of wide tubes, as compared with the fixed gradients in the narrow tube of the manometer. The disparity of values is one which can only be settled in the lapse of much more time, inasmuch as \dot{h} is as yet too small to be trustworthy. If it takes the divers nearly a month to reach equilibrium conditions, it should take the manometer much longer, and the experience with the long divers in §41 may be recalled. Any small difference in the gas above the two meniscuses of the manometer, produced, for instance, in closing the tube with the blow-pipe, would be a serious consideration in case of the small amount of gas in either shank of the U-tube. Correlative experiments with wider tubes naturally suggest themselves, and the same have been installed to be read off next year.

65. Summary.—The data found in the above observations have been summarized in table 46, in which the system of gas and liquid undergoing diffusion is specified in the first column, the table from which the data are derived in the second, and the vessel in which the experiments were made in the third. The vessels *A* and *H* were of the double-tube pattern, the remainder being single-tube apparatus. The latter admit of much easier treatment; being much less complicated, they probably lead to results which are for this reason more trustworthy, particularly as every apparatus is eventually standardized by the results of the diffusion of air through pure water.

TABLE 46.—Summary.

System.	Table.	Vessel.	cm. ³ /day.	10 ⁴ %.	Days.	<i>h</i> '	<i>h</i> '''	<i>a</i>	10 ⁴ %.	P. ct. of solution.
Air—H ₂ O—Air	22	H	0.0185	214	36	7.42	7.42	7.3	0.897
	18	E	.0042	49.2	20	4.80	10.30	7.1	.374
	20	EE	.0032	269	34	11.40	3.71	7.1	.640
	19	F	.0082	95.5	42	4.23	9.23	7.1	.779
	16	A	.0505	585	50	4.82	6.88	6.8	3.380
	16	A	.0363	443	13	4.82	6.88	6.8	2.560
	17	A	.0225	260	37	5.07	6.78	6.8	1.432
Hydrogen—H ₂ O—Hydrogen	17	A	.0072	84	37	5.07	6.78	6.8	.463
	23	H	.0600	926	36	9.33	7.54	7.3	3.383
Air—KCl—Air	24	B	.0072	84	35	8.84	4.47	11.3	.137	17.2
Air— $\frac{KCl}{2}$ —Air	25	B	.0115	133	26	10.05	4.30	11.3	.209	9.9
Air— $\frac{KCl}{4}$ —Air	26	B	.0222	257	25	10.18	4.47	11.3	.423	4.2
Air— $\frac{KCl}{8}$ —Air	27	B	.0145	167.8	41	11.47	4.12	11.3	.236	2.7
Air—NaCl—Air	28	F	.0035	40.6	38	12.38	4.50	7.1	.088	19.6
Air— $\frac{NaCl}{2}$ —Air	29	F	.0073	84	41	12.38	4.36	7.1	.192	9.5
Air—CaCl ₂ —Air	30	C	.0062	72.3	35	9.00	5.45	6.4	.213	21.4
Air— $\frac{CaCl_2}{2}$ —Air	31	C	.0072	84	21	8.58	5.62	6.4	.352	12.2
Air— $\frac{CaCl_2}{4}$ —Air	32	C	.0067	78.1	30	8.99	5.22	6.4	.254	7.1
	32	C	.0097	113	30	8.99	5.22	6.4	.368	7.1
Air— $\frac{CaCl_2}{8}$ —Air	33	C	.0250	290	36	9.72	5.37	6.4	.946	3.3
	33	C	.0197	228	36	9.72	5.37	6.4	.744	3.3
Air—BaCl ₂ —Air	34	..	.0077	89.8	15	13.69	5.04	7.1	.192	17.0
Air— $\frac{BaCl_2}{2}$ —Air	35	..	.0082	95.5	25	12.90	5.10	7.1	.225	9.6
	35	..	.0093	102	25	12.90	5.10	7.1	.241	9.6
Air— $\frac{BaCl_2}{4}$ —Air	36	..	.0088	101.3	41	13.55	5.07	7.1	.244	4.8
Air—K ₂ SO ₄ —Air	37	..	.0137	159	22	12.79	5.74	7.2	.402	8.0
Air— $\frac{K_2SO_4}{2}$ —Air	38	..	.0100	116	18	11.46	5.85	7.2	.322	4.0
	38	..	.0120	140	18	11.46	5.85	7.2	.388	4.0
Air— $\frac{K_2SO_4}{4}$ —Air	39	..	.0100	116	36	13.00	5.63	7.2	.302	1.7
Air—Na ₂ SO ₄ —Air	40	EE	.0070	81	24	13.11	4.04	7.1	.168	13.7
	40	EE	.0095	110	24	13.11	4.04	7.1	.229	13.7
Air— $\frac{Na_2SO_4}{2}$ —Air	41	EE	.0065	75.3	36	12.83	3.85	7.1	.164	6.3
Air—FeCl ₃ —Air	42	H	.0012	14.6	29	8.70	7.59	7.3	.045	27.3
Air— $\frac{FeCl_3}{2}$ —Air	43	H	.0028	31.9	20	10.44	7.18	7.3	.094	14.3
Air—AlCl ₃ —Air	44	A	.0023	26.1	36	10.80	6.76	6.8	.076	20.2

The fourth column contains the number of cubic centimeters lost by the diver (by diffusion) per day, the fifth the corresponding loss, v_0 , per second, and the sixth the duration of the experiment in days. The quantity h'' in the seventh column shows the height of the free surface of liquid in

the diver above its horizontal circular mouth, the area of which, a , is given in the eighth column, while h''' is the difference of level of the free surface in the diver and the free surface outside of and above it, during the occurrence of diffusion. The coefficient of diffusion, *i. e.*, the number of cubic centimeters at standard temperature and pressure which diffuse across an orthogonal square centimeter per unit pressure gradient, and the percentage of solute in solution (grams of salt per 100 grams of solution) are contained in the last two columns.

The cases of air and of hydrogen have already been adequately discussed above and the various exceptional values, particularly the case of vessel *A*, interpreted. The mean rate for air may be put $\kappa \times 10^{10} = 0.9$ and for hydrogen (the value in the present chapter is probably preferable because of the greater care taken to exclude air), $\kappa \times 10^{10} = 3.4$.

So far as this ratio is trustworthy, it is not out of proportion with the ratios of mean molecular velocities for these gases. It is unfortunate that the experiments above had to be made with a compound gas like air; but the special difficulties involved in endeavoring to obtain similar results with any simple gas, *i. e.*, the provision of an artificial atmosphere in the latter case, etc., seemed, at the outset at least, to more than counterbalance the advantages of a single gas. Whether this adoption was actually a wise step or not will appear in the future. It would not be so difficult to work with hydrogen if a region of constant temperature sufficiently large to contain all apparatus, including the air pump and the observer, were available; but this has not been the case. A thermostat for such a purpose would not only have to be large but would have to be free from breakdown for years. At the beginning of the experiments much time (*i. e.*, several weeks) must be allowed before a definite rate of diffusion can be said to appear; but a steady condition eventually presents itself, beginning, as a rule, abruptly, and it is not impossible that different liquids select differently constituted gases for final diffusion. Such a gas may be richer or poorer in oxygen than ordinary air.

The use of distilled water, which is usually inadequately aerated, as well as the use of tap water otherwise pure, are in this respect objectionable; for the former will contain a deficiency and the latter an excess of air. Any change of the gases in the room, as produced, for instance, by gas-burners or by hydrocarbon vapors or even by decay, is to be looked at with apprehension. In this presence the partial pressure of the exceptional gas is zero within the diver and the gradient is at once brought to bear at its maximum value. When gas has been dissolved in a liquid under pressure, the growth of bubbles on rough objects may be noticed long after a tendency to effervesce has completely vanished, so that in all cases fresh solutions seem to require a long time to reach a normal content of gas. The composition of a mixture is usually different in solution and out of it. In this respect also the temperature variation and the solubility of a gas are menacing; for if the gas were merely added to or deducted from the gas-

content of the diver, the result would be nil in the lapse of time, supposing there is no continuous mean rise or fall of temperature, the latter in its effects being indistinguishable from diffusion. The issue in question, however, is the change of composition of the imprisoned air, which becomes either relatively rich or poor in oxygen; and this modifies the gradients correspondingly. Any change of barometric pressure, moreover, is felt in the gas inside and outside of the diver at once, but it does not follow that it is also felt in the pores of the liquid. There will probably be diffusion out of and into the pores of the liquid as the barometer falls and rises, respectively, at a slow rate and thus not easily observable. The presence, finally, of any absorbent of a gas within the liquid, as, for instance, the case of bright copper, may confuse the result.

Finally, the discrepancy between the results obtained in a closed manometer in the lapse of years and the above results with the diver in the lapse

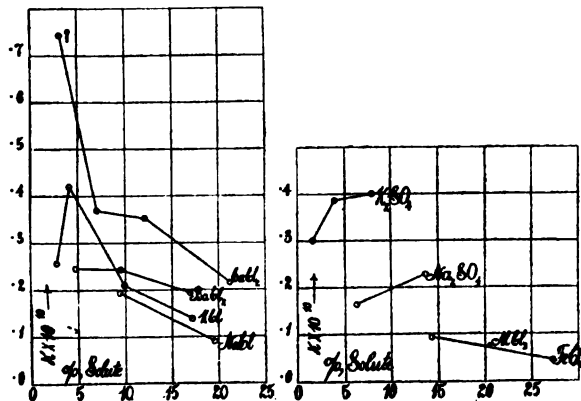

FIG. 38.—Chart showing variation of volume coefficients of diffusion at standard pressure and temperature with composition and density of solution.

of months must be considered. These experiments have been in progress for so short a time, relatively speaking, that all interpretation is merely tentative. It would not be consistent if carried into detail. Nevertheless, if we suppose the gas contained in the pores of a liquid to be relatively fixed, then the presence of convection currents due to gradual changes of temperature on the outside of the apparatus would carry the more compressed gas of the lower level to the free surface, and conversely. Such an effect, which is equivalent to an increase of gradient, being absent in the narrow tube of the manometer, diffusion should be slower in the latter case, as it appears to be. Here, however, the identity of the small amount of gas in the two shanks of the U-tube is in question.

If the results of table 46 be graphically represented for each solution, so that the coefficient of diffusion may appear in its variation with the strength of solution, the sets of curves given in fig. 38 will exhibit the chief content of the table. From these curves it appears that the diffusion of a gas in

general decreases rapidly with the strength of the solution, *i. e.*, the physical pores of the solvent are invariably at least virtually stopped up by the solute. But the decrease of diffusivity κ occurs at a rapidly *retarded* rate with the strength of solution, so that the chief effect is already patent for solutions lying within 5 to 10 per cent strength. The water of the solvent should therefore be very pure.

Different solutions, moreover, behave quite differently. Thus the alkalis KCl and NaCl are more powerful in decreasing the diffusivity of a gas than the chlorides or alkaline earths BaCl_2 and CaCl_2 , at least so far as the data now available allow an assertion. One would naturally anticipate some result here with a bearing on the periodic law, but the time for this is not yet at hand, and the conditions are liable to be variously complicated. Thus the continued dilution of a concentrated solution does not necessarily imply the continued decrease of the diffusivity of the gas through it. The table shows instances, *e. g.*, CaCl_2 , K_2SO_4 , in which the dilute solutions show lower diffusion coefficients than the more concentrated solutions. One would naturally attribute such a result (if indefinitely substantiated), to the formation of hydrates at different favorable strengths of solution, by which the structure of the solution is fundamentally modified.

In conclusion, therefore, the present experiments, in spite of all the labor and patience spent upon them, have done no more than enhance the interest of the subject in a very real degree. That the internal structure of the liquid may in a measure be explored in this way admits of no doubt; but the path of the explorer has proved very much more arduous than the initial trials promised. The work will nevertheless be continued in various directions.



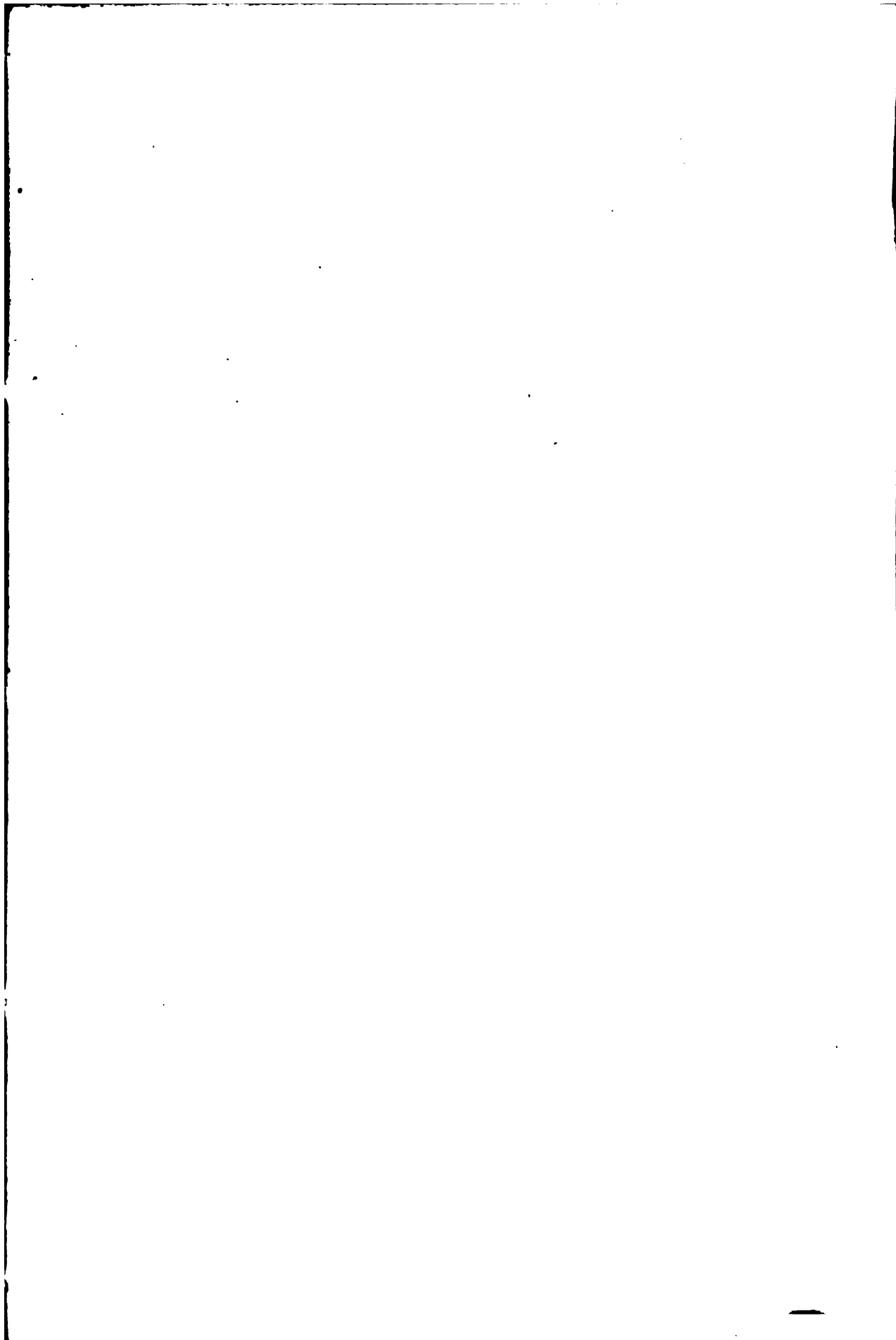

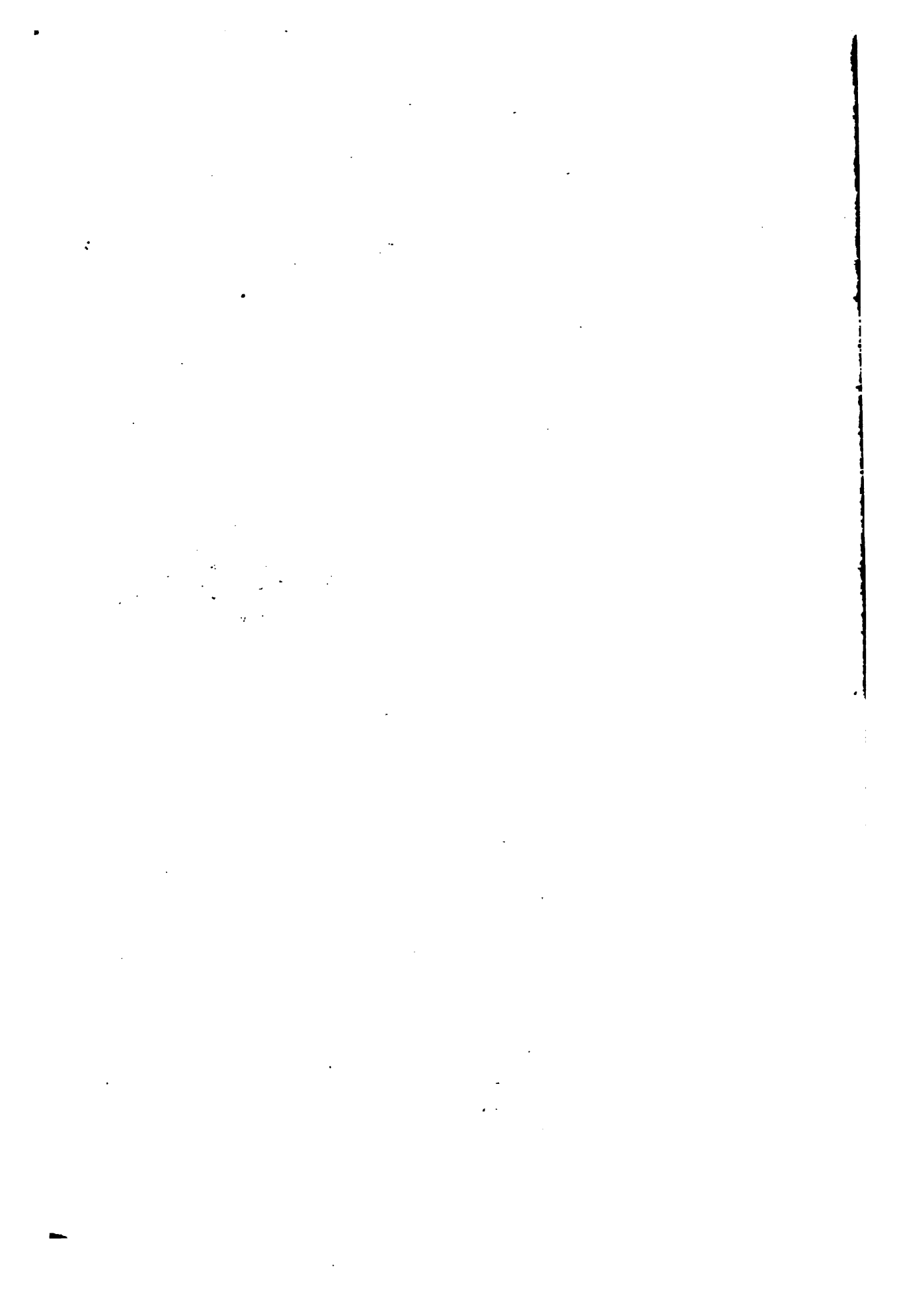





This book should be returned to
the Library on or before the last date
stamped below.

A fine of five cents a day is incurred
by retaining it beyond the specified
time.

Please return promptly.

~~LIBRARY~~

